

2022

BAGLiNOX



- Ⓔ Tel. 948 290 552
- Ⓟ Tel. 932 777 370
- Ⓣ Tél. 06.38.12.70.71
- ⒼⓅ Tel. 07787 319786

Designed by Baglinox[®]

www.baglinox.com



Desde 1978

Fundada en 1978, Baglinox es líder nacional en la fabricación de perfiles decorativos para suelos. En la actualidad cuenta con dos plantas de producción situadas en la comarca de Pamplona, España.

Baglinox dispone de una extensa red de distribución que incluye a mayoristas de pavimentos y maderas, instaladores de pavimentos, grandes superficies, establecimientos de bricolaje, almacenes de construcción y ferreterías. Baglinox está homologado como proveedor de los operadores más importantes del mercado.

Baglinox, con sus más de 30.000 referencias, ofrece la gama más amplia de perfiles clasificados por:

Materiales y acabados: Más de 200 acabados disponibles; Acero inoxidable, acero latonado, aluminio (anodizado oro, plata, bronce e inoxidable), plástico efecto madera, madera natural y CPL.

Diseños: Igual nivel, desniveles, escaleras, juntas de dilatación, remates finales, multifunción, zócalos, etc.

Sistemas de sujeción: Perfiles para atornillar, autoadhesivos, fijación oculta, sistema 'clic' multifijación, etc.

Baglinox exporta el 40% de su producción a diversos países de Europa, África, Asia y América.



Depuis 1978

La société Baglinox, fondée en 1978, est le leader espagnol dans la fabrication de profils de finition pour revêtements de sols. Actuellement, Baglinox possède deux centres de production dans la région de Pampelune - Navarre (Espagne, à 50 kilomètres de la frontière française).

Le réseau de distribution de Baglinox inclut des négoce bois, négoce matériaux, spécialistes parquet, installateurs de revêtements, grandes surfaces, établissements de bricolage et quincailleries. Baglinox est homologué comme fournisseur des opérateurs les plus importants du marché.

Baglinox offre la gamme de profils la plus large, avec plus de 30.000 références. Les profils Baglinox peuvent être classifiés par:

Matériaux et finitions: Plus de 200 finitions; acier inoxydable, acier laitonné, aluminium (anodisé argent, or, bronze et inox), imitation bois et gamme Woodline (placage bois).

Dessins: Même niveau, différence de niveau (1-27 mm), nez de marche, joints de dilatation, bordures, plinthes, etc.

Systèmes de fixation: Profils à visser, adhésifs, système à fixation invisible, système à clipser, etc.

Baglinox exporte 40% de sa production dans plusieurs pays d'Europe, d'Amérique, d'Afrique et d'Asie.

Since 1978

Founded in 1978, Baglinox is Spain's leading manufacturer of finishing profiles. Baglinox currently has two manufacturing plants located in the area of Pamplona, in the North of Spain.

Baglinox has a large distribution network in place, with outlets in all sectors of the flooring market, from multinational hardware stores, flooring wholesalers, specialist flooring shops to the construction industry.

Baglinox, with more than 30,000 references offers you a wide range of profiles classified by:

Materials and finishings: More than 200 finishes; stainless steel, aluminium (silver, gold, bronze and steel), brass plated steel, wood plastic decor, wood veneered finish, and CPL decor.

Designs: Cover strips, dilatation joints, transition ramps, square edges, stair noses, angles, skirtings, etc.

Fixing systems: Drilled profiles, self-adhesive profiles, invisible fixing, Multifix click system, etc.

Baglinox exports the 40% of its production to different countries in Europe, Africa, America and Asia.



Política medioambiental

Las plantas de producción de Baglinox se autoabastecen de energía eléctrica mediante paneles solares fotovoltaicos.

Environmental policy

Baglinox production plants are self-sufficient in electricity by using photovoltaic solar panels.

Politique environnementale

Les usines de production de Baglinox sont autosuffisantes en électricité grâce à des panneaux solaires photovoltaïques.

Fábrica / Factory / Usine

Pol. Comarca I, calle L, 27.
31160 Orcoyen. Navarra. España
Tel. (+34) 948 290 552

Almacén en Madrid / Madrid branch Succursale à Madrid



Pol. Los Olivos. C/ Empleo 39,
28906 Getafe. Madrid
Tel. 91 129 12 12

Almacén en Barcelona / Barcelona branch Succursale à Barcelone



C/Crom 68, Baix. 08907 L'Hospitalet
de Llobregat. Barcelona
Tel. 93 474 28 53

PÁGINA / PAGE / PAGE

6

Quick&Pro

Perfiles de aluminio autoadhesivos
Aluminium self-adhesive profiles
Profils en aluminium autoadhésifs

11

Sistema Multifijación / Multifix System / Système à clipser

Perfiles de aluminio con base
Aluminium profiles on a base
Profils en aluminium avec base

23

Soluciones de aluminio / Aluminium solutions / Solutions en aluminium

43

Woodline

Perfiles recubiertos de madera natural
Real wood veneered profiles
Profils avec placage bois véritable

47

Basic line

Perfiles de acero
Steel profiles
Profils en acier

59

Felpudos / Entrance mats / Tapis d'entrée

61

Zócalos / Skirting / Plinthes

72

Accesorios / Accessories / Accessoires

74

Bricolaje y expositores / DIY and display stands / Bricolage et présentoirs

76

Acabados / Finishes / Finitions



Quick&Pro

Aluminio - Aluminium - Aluminium

- Estructura **100% aluminio**.
- Fijación mediante adhesivo de alta calidad **hot-melt**.
- Amplia gama de colores: **50 colores** disponibles en stock y acabados a medida.
- Alta **resistencia** a la humedad, el desgaste y los impactos.
- Gama **profesional** de fácil aplicación.
- Perfiles **extraplano**s.

- **100% aluminium** structure.
- Fixation by means of high quality **hot-melt** adhesive.
- Wide range of colours: **50 colours** in stock and made-to-measure finishes.
- High **resistance** to humidity, wear and tear and impacts.
- Easy installation **professional** range.
- **Ultra-slim**.

- Structure **100% aluminium**.
- Fixation par adhésif de haute qualité **hot-melt**.
- Large gamme de couleurs: **50 couleurs** en stock et finitions sur mesure.
- Haute **résistance** à l'humidité, à l'usure et aux impacts.
- Gamme **professionnelle** avec installation facile.
- Profils **extra-plats**.

Multifix - Multifix System - Système à clipser

Aluminio - Aluminium - Aluminium

- Estructura **100% aluminio**.
- Fijación perfecta mediante **clip** 100% aluminio.
- Amplia gama de colores: **50 colores** disponibles en stock y acabados a medida.
- Alta **resistencia** a la humedad, el desgaste y los impactos.
- Gama **profesional**.
- Perfiles **extraplano**s.
- Sistema conforme a **normativas** de instalación de fabricantes de suelos.

- **100% aluminium** structure.
- Perfect fixation by 100% aluminium **clipping**.
- Wide range of colours: **50 colours** in stock and made-to-measure finishes.
- High **resistance** to humidity, wear and tear and impacts.
- **Professional** range.
- **Ultra-slim**.
- It performs installation **regulations** of flooring manufacturers.

- Structure **100% aluminium**.
- Fixation par **clipsage** 100% aluminium.
- Large gamme de couleurs: **50 couleurs** en stock et finitions sur mesure.
- Haute **résistance** à l'humidité, l'usure et les impacts.
- Gamme **professionnelle**.
- Profils **extra-plats**.
- Adéquat aux **normes** d'installation des fabricants de revêtements.

Basic line

Acero - Steel - Acier

- Núcleo de **acero**.
- Fijación mediante adhesivo de alta calidad **hot-melt** o **tornillos**.
- Gama **básica** de colores.
- Alta **resistencia** a la humedad, el desgaste y los impactos.
- Perfiles recubiertos mediante tecnología **coil coating**.
- **Amplia gama** de productos.
- Fabricación totalmente **automatizada**.
- Perfiles **extraplano**s.

- Core made of **steel**.
- Fixation by means of high quality **hot-melt** adhesive or **screws**.
- **Basic** colour range.
- High **resistance** to humidity, wear and tear and impacts.
- **Coil coating** technology.
- **Wide range** of products.
- Totally **automated** manufacturing.
- **Ultraslim** profiles.

- Noyau en **acier**.
- Fixation par adhésif de haute qualité **hot-melt** ou **vis**.
- Gamme **basique** de couleurs.
- Haute **résistance** à l'humidité, l'usure et les impacts.
- Profils recouverts grâce à la technologie **coil coating**.
- **Large gamme** de produits.
- Fabrication totalement **automatisée**.
- Profils **extra-plats**.

Perfiles de aluminio autoadhesivos.
Acabado perfecto y fácil instalación.

Aluminium self-adhesive profiles.
Perfect finish and easy installation.

Profils en aluminium autoadhésifs.
Finition parfaite et installation facile.

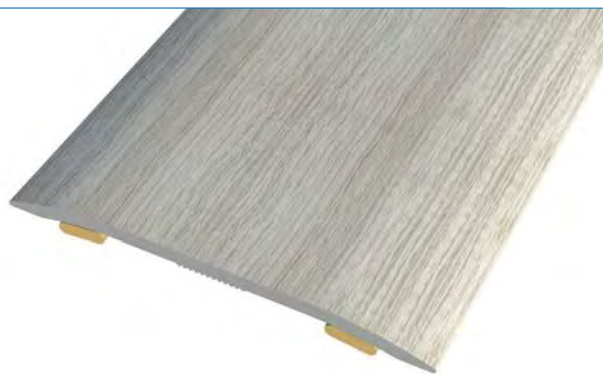

INVISIBLE

Quick&Pro

Perfiles de aluminio con base. Permiten la dilatación de los pavimentos. La opción profesional.

Aluminium profiles on a base. They let the expansion of the flooring. The professional choice.

Profils en aluminium avec base. Ils permettent la dilatation des revêtements.

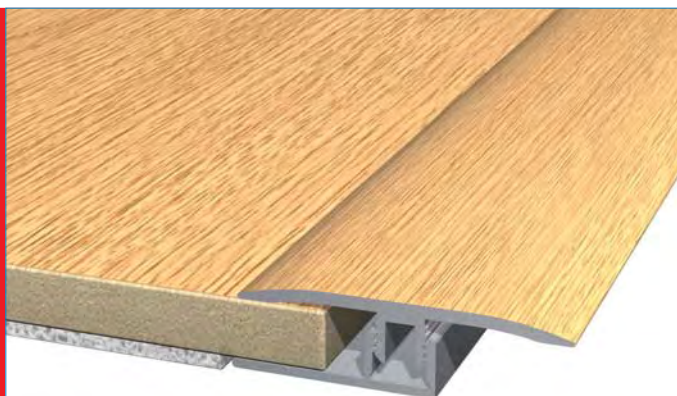

Sistema Multifijación
Multifix System
Système à clipser

Perfiles de acero. La solución económica.

Steel profiles. The budget choice.

Profils en acier. L'option économique.



Basic Line

QUICK & PRO

Perfiles de aluminio
Aluminium profiles
Profils en aluminium

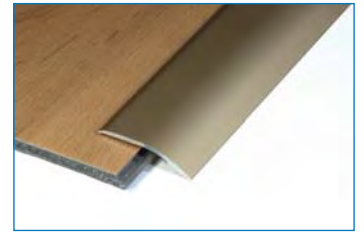

INVISIBLE



Ahorro

Volumen mínimo

Gama de colores

Estructura resistente

Garantía

Resistencia al desgaste

Resistencia a la humedad

Fijación perfecta

Cost-effective - Colour range - Guarantee - Minimum volume
Resistant structure - Resistance to wear and tear and humidity - Perfect fixation

Économique - Gamme de couleurs - Garantie - Volume minimal
Structure résistante - Résistance à l'usure et à l'humidité - Fixation parfaite

50 acabados disponibles en stock



Consulte listado de acabados actualizado en www.baglinox.com y su correspondencia con marcas de suelos

50 decors available in stock. Please consult the updated decors' list in our website and their correspondence to flooring brands.

50 décors disponibles en stock. Veuillez consulter la liste de décors actualisée sur notre site web et sa correspondance avec les marques de sols.



aluminio - aluminium - aluminium

INVISIBLE

Disponibles también en 93 cm. Mínimo 15 un. por ref.
 Available in 93 cm. Minimum 15 un. per ref.
 Disponibles aussi en 93 cm. Minimum 15 un. par réf.

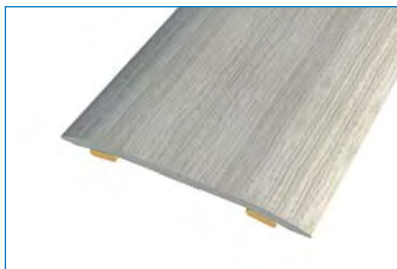

(*) Color no disponible en 93 cm
 (*) Colour not available in 93 cm
 (*) Couleur non disponible en 93 cm

370

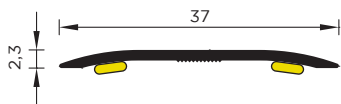

372
3-12 mm



	90 cm	270 cm
ALUM. 03	3700309001B	3700327001C
ALUM. 04	3700409001B	3700427001C
ALUM. 05	3700509001B	3700527001C
€/u	5,11	14,51
ALUM. 07	3700709001B	3700727001C
ALUM. 25	3702509001B	3702527001C
€/u	6,72	19,35
11	3701109001B	3701127001C
12	3701209001B	3701227001C
17	3701709001B	3701727001C
20	3702009001B	3702027001C
33	3703309001B	3703327001C
35	3703509001B	3703527001C
37	3703709001B	3703727001C
40	3704009001B	3704027001C
42	3704209001B	3704227001C
44	3704409001B	3704427001C
45	3704509001B	3704527001C
49	3704909001B	3704927001C
70	3707009001B	3707027001C
72	3707209001B	3707227001C
73	3707309001B	3707327001C
84	3708409001B	3708427001C
85	3708509001B	3708527001C
87	3708709001B	3708727001C
91	3709109001B	3709127001C
94	3709409001B	3709427001C
98	3709809001B	3709827001C
0A	3700A09001B	3700A27001C
5A	3705A09001B	3705A27001C
6A	3706A09001B	3706A27001C
6B	3706B09001B	3706B27001C
7A	3707A09001B	3707A27001C
7B	3707B09001B	3707B27001C
8B	3708B09001B	3708B27001C
A4	370A409001B	370A427001C
A5	370A509001B	370A527001C
B1	370B109001B	370B127001C
B3	370B309001B	370B327001C
C9	370C909001B	370C927001C
D4	370D409001B	370D427001C
D5	370D509001B	370D527001C
D7	370D709001B	370D727001C
D9	370D909001B	370D927001C
E2	370E209001B	370E227001C
S5	370S509001B	370S527001C
S8	370S809001B	370S827001C
S9	370S909001B	370S927001C
T2	370T209001B	370T227001C
T3	370T309001B	370T327001C
Z3	370Z309001B	370Z327001C
€/u	7,72	22,59

	90 cm	270 cm
	3720309001B	3720327001C
	3720409001B	3720427001C
	3720509001B	3720527001C
€/u	5,11	14,51
	3720709001B	3720727001C
	3722509001B	3722527001C
€/u	6,72	19,35
	3721109001B	3721127001C
	3721209001B	3721227001C
	3721709001B	3721727001C
	3722009001B	3722027001C
	3723309001B	3723327001C
	3723509001B	3723527001C
	3723709001B	3723727001C
	3724009001B	3724027001C
	3724209001B	3724227001C
	3724409001B	3724427001C
	3724509001B	3724527001C
	3724909001B	3724927001C
	3727009001B	3727027001C
	3727209001B	3727227001C
	3727309001B	3727327001C
	3728409001B	3728427001C
	3728509001B	3728527001C
	3728709001B	3728727001C
	3729109001B	3729127001C
	3729409001B	3729427001C
	3729809001B	3729827001C
	3720A09001B	3720A27001C
	3725A09001B	3725A27001C
	3726A09001B	3726A27001C
	3726B09001B	3726B27001C
	3727A09001B	3727A27001C
	3727B09001B	3727B27001C
	3728B09001B	3728B27001C
	372A409001B	372A427001C
	372A509001B	372A527001C
	372B109001B	372B127001C
	372B309001B	372B327001C
	372C909001B	372C927001C
	372D409001B	372D427001C
	372D509001B	372D527001C
	372D709001B	372D727001C
	372D909001B	372D927001C
	372E209001B	372E227001C
	372S509001B	372S527001C
	372S809001B	372S827001C
	372S909001B	372S927001C
	372T209001B	372T227001C
	372T309001B	372T327001C
	372Z309001B	372Z327001C
€/u	7,72	22,59

aluminio - aluminium - aluminium



371



	90 cm	270 cm
ALUM. 03	3710309001B	3710327001C
€/u	4,24	12,72
ALUM. 25	3712509001B	3712527001C
€/u	5,82	17,48
11	3711109001B	3711127001C
12	3711209001B	3711227001C
13	3711309001B	3711327001C
33	3713309001B	3713327001C
73	3717309001B	3717327001C
S5	3715509001B	3715527001C
€/u	6,87	20,60

90 cm 15 u. 270 cm 10 u.



375

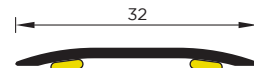

	90 cm	270 cm
ALUM. 03	3750309001B	3750327001C
€/u	5,04	14,25
ALUM. 07	3750709001B	3750727001C
ALUM. 25	3752509001B	3752527001C
€/u	6,65	19,07
11	3751109001B	3751127001C
12	3751209001B	3751227001C
13	3751309001B	3751327001C
33	3753309001B	3753327001C
73	3757309001B	3757327001C
S5	3755509001B	3755527001C
€/u	7,61	21,74



323

Adh.
40 mm
0-12 mm
2 en 1 / 2 in 1

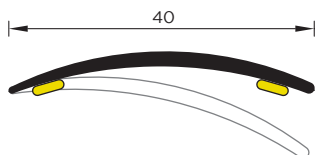

	90 cm	270 cm
ALUM. 03	3230309001B	3230327001C
€/u	4,84	14,78
ALUM. 25	3232509001B	3232527001C
€/u	6,44	19,58
11	3231109001B	3231127001C
12	3231209001B	3231227001C
13	3231309001B	3231327001C
33	3233309001B	3233327001C
73	3237309001B	3237327001C
S5	3235509001B	3235527001C
€/u	7,37	22,07

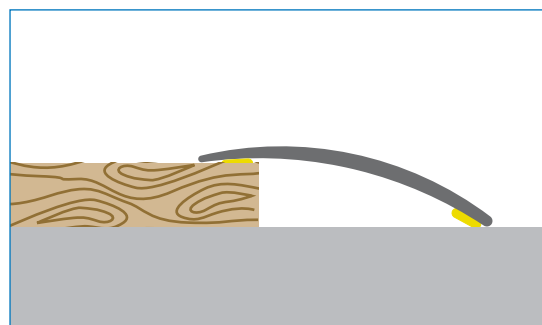
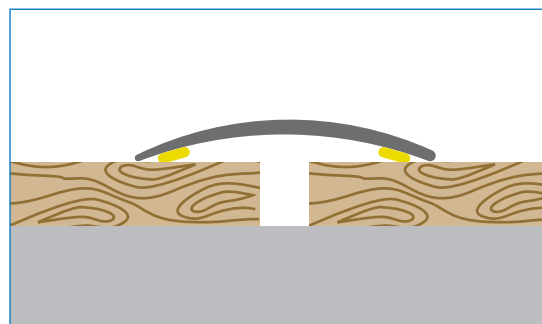

90 cm 15 u.
270 cm 10 u.



374
0-6 mm

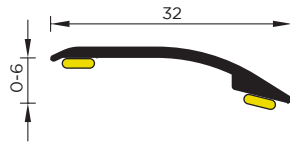

	90 cm	270 cm
ALUM. 03	3740309001B	3740327001C
€/u	5,04	14,25
ALUM. 07	3740709001B	3740727001C
ALUM. 25	3742509001B	3742527001C
€/u	6,65	19,07
11	3741109001B	3741127001C
12	3741209001B	3741227001C
13	3741309001B	3741327001C
33	3743309001B	3743327001C
73	3747309001B	3747327001C
S5	3745509001B	3745527001C
€/u	7,61	21,74

aluminio - aluminium - aluminium

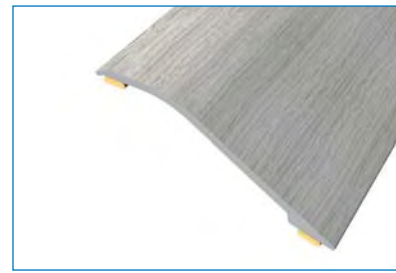

376
5-20 mm

parquet

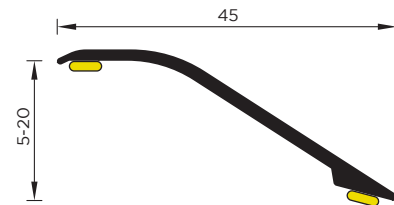

	90 cm	270 cm
ALUM. 03	3760309001B	3760327001C
€/u	8,06	22,53
ALUM. 25	3762509001B	3762527001C
€/u	9,82	27,71
11	3761109001B	3761127001C
12	3761209001B	3761227001C
13	3761309001B	3761327001C
33	3763309001B	3763327001C
73	3767309001B	3767327001C
S5	3765509001B	3765527001C
€/u	10,93	31,34



391
5-27 mm

parquet

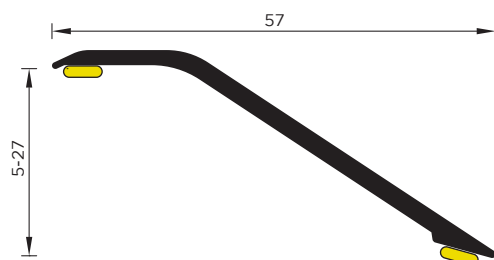

	90 cm	270 cm
ALUM. 03	3910309001B	3910327001C
€/u	9,38	28,13
11	3911109001B	3911127001C
12	3911209001B	3911227001C
13	3911309001B	3911327001C
33	3913309001B	3913327001C
73	3917309001B	3917327001C
S5	3915509001B	3915527001C
€/u	11,92	35,76



332
7-14 mm

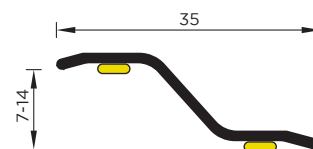

	90 cm	270 cm
ALUM. 03	3320309001B	3320327001C
€/u	5,11	14,51
11	3321109001B	3321127001C
12	3321209001B	3321227001C
13	3321309001B	3321327001C
33	3323309001B	3323327001C
73	3327309001B	3327327001C
S5	3325509001B	3325527001C
€/u	7,72	22,59

485

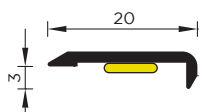

270 cm

ALUM. 03	4850327001C	12,72 €/u
ALUM. 25	4852527001C	17,48 €/u
LAQ. - LB	485LB27001C	12,72 €/u

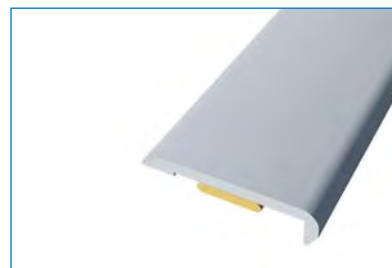

483

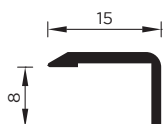

270 cm

ALUM. 03	4830327000C	10,96 €/u
ALUM. 25	4832527000C	15,57 €/u
LAQ. - LA	483LA27000C	10,96 €/u
LAQ. - LB	483LB27000C	10,96 €/u



417

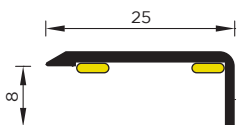

270 cm

ALUM. 03	4170327001C	
€/u		15,69
ALUM. 07	4170727001C	
ALUM. 25	4172527001C	
€/u		20,51
LAQ. - LA	417LA27001C	
LAQ. - LB	417LB27001C	
€/u		15,69
11	4171127001C	
12	4171227001C	
13	4171327001C	
33	4173327001C	
73	4177327001C	
S5	417S527001C	
€/u		21,74



415

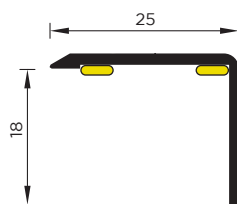

270 cm

//// ALUM. 03 E ///	4150327001C	
//// ALUM. 07 E ///	4150727001C	
€/u		19,97
//// ALUM. 25 ///	4152527001C	
€/u		24,99
11	4151127001C	
12	4151227001C	
13	4151327001C	
33	4153327001C	
73	4157327001C	
S5	415S527001C	
€/u		25,27

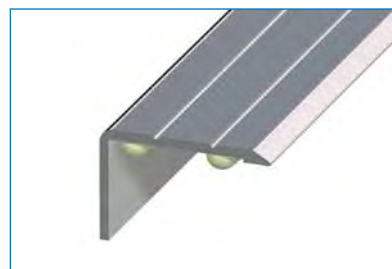

482

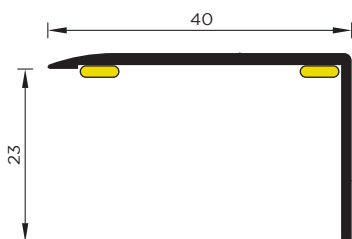

270 cm

ALUM. 03	4820327001C	
€/u		23,83
ALUM. 25	4822527001C	
€/u		29,06
11	4821127001C	
12	4821227001C	
13	4821327001C	
33	4823327001C	
73	4827327001C	
S5	482S527001C	
€/u		30,55



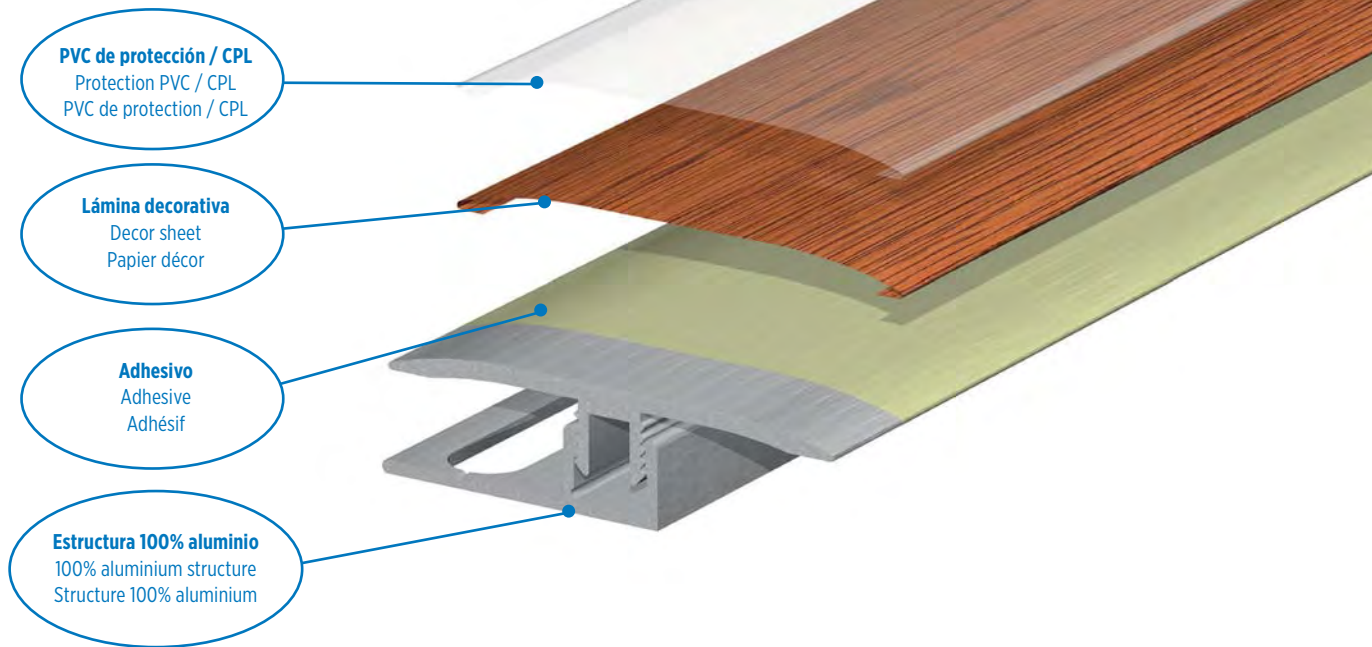

SISTEMA MULTIFIJACIÓN MULTIFIX SYSTEM SYSTÈME À CLIPSER

Perfiles de aluminio con base. La elección profesional
Aluminium profiles on a base. The professional choice
Profils en aluminium avec base. Le choix du professionnel

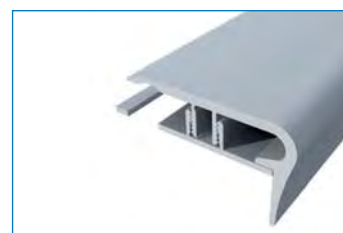

Ahorro	Volumen mínimo
Gama de colores	Estructura resistente
Garantía	Resistencia al desgaste
Resistencia a la humedad	Fijación perfecta

Cost-effective - Colour range - Guarantee - Minimum volume
Resistant structure - Resistance to wear and tear and humidity - Perfect fixation

Économique - Gamme de couleurs - Garantie - Volume minimale
Structure résistante - Résistance à l'usure et à l'humidité - Fixation parfaite



50 acabados disponibles en stock



Consulte listado de acabados actualizado en www.baglinox.com y su correspondencia con marcas de suelos

50 decors available in stock. Please consult the updated decors' list in our website and their correspondence to flooring brands.

50 décors disponibles en stock. Veuillez consulter la liste de décors actualisée sur notre site web et sa correspondance avec les marques de sols.

511 Junta / T-motion / Joint de dilatation

H: 5-24 mm

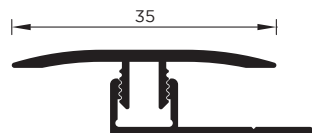

H: 5-9 mm

90 cm



H: 5-9 mm

270 cm



Sin base / No base / Sans base
Bases pg. 20
270 cm



ALUM. 03	5110309013M	5110327013C	5100327000C
€/u	8,81	24,50	19,07
ALUM. 07	5110709013M	5110727013C	5100727000C
ALUM. 25	5112509013M	5112527013C	5102527000C
€/u	10,50	29,45	24,92
11	5111109013M	5111127013C	5101127000C
12	5111209013M	5111227013C	5101227000C
17	5111709013M	5111727013C	5101727000C
20	5112009013M	5112027013C	5102027000C
33	5113309013M	5113327013C	5103327000C
35	5113509013M	5113527013C	5103527000C
37	5113709013M	5113727013C	5103727000C
40	5114009013M	5114027013C	5104027000C
42	5114209013M	5114227013C	5104227000C
44	5114409013M	5114427013C	5104427000C
45	5114509013M	5114527013C	5104527000C
49	5114909013M	5114927013C	5104927000C
70	5117009013M	5117027013C	5107027000C
72	5117209013M	5117227013C	5107227000C
73	5117309013M	5117327013C	5107327000C
84	5118409013M	5118427013C	5108427000C
85	5118509013M	5118527013C	5108527000C
87	5118709013M	5118727013C	5108727000C
91	5119109013M	5119127013C	5109127000C
94	5119409013M	5119427013C	5109427000C
98	5119809013M	5119827013C	5109827000C
0A	5110A09013M	5110A27013C	5100A27000C
5A	5115A09013M	5115A27013C	5105A27000C
6A	5116A09013M	5116A27013C	5106A27000C
6B	5116B09013M	5116B27013C	5106B27000C
7A	5117A09013M	5117A27013C	5107A27000C
7B	5117B09013M	5117B27013C	5107B27000C
8B	5118B09013M	5118B27013C	5108B27000C
A4	511A409013M	511A427013C	510A427000C
A5	511A509013M	511A527013C	510A527000C
B1	511B109013M	511B127013C	510B127000C
B3	511B309013M	511B327013C	510B327000C
C9	511C909013M	511C927013C	510C927000C
D4	511D409013M	511D427013C	510D427000C
D5	511D509013M	511D527013C	510D527000C
D7	511D709013M	511D727013C	510D727000C
D9	511D909013M	511D927013C	510D927000C
E2	511E209013M	511E227013C	510E227000C
S5	511S509013M	511S527013C	510S527000C
S8	511S809013M	511S827013C	510S827000C
S9	511S909013M	511S927013C	510S927000C
T2	511T209013M	511T227013C	510T227000C
T3	511T309013M	511T327013C	510T327000C
Z3	511Z309013M	511Z327013C	510Z327000C
€/u	10,95	30,66	24,35

569 Transición / Transition-ramp / Transition

H: 6-14 mm

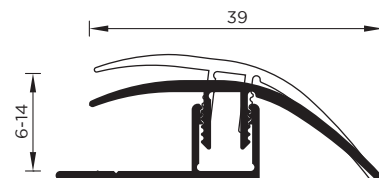

H: 6-14 mm

90 cm



H: 6-14 mm

270 cm



ALUM. 03	5690309013M	5690327013C
€/u	9,92	28,06
ALUM. 07	5690709013M	5690727013C
ALUM. 25	5692509013M	5692527013C
€/u	11,68	33,16
11	5691109013M	5691127013C
12	5691209013M	5691227013C
17	5691709013M	5691727013C
20	5692009013M	5692027013C
33	5693309013M	5693327013C
35	5693509013M	5693527013C
37	5693709013M	5693727013C
40	5694009013M	5694027013C
42	5694209013M	5694227013C
44	5694409013M	5694427013C
45	5694509013M	5694527013C
49	5694909013M	5694927013C
70	5697009013M	5697027013C
72	5697209013M	5697227013C
73	5697309013M	5697327013C
84	5698409013M	5698427013C
85	5698509013M	5698527013C
87	5698709013M	5698727013C
91	5699109013M	5699127013C
94	5699409013M	5699427013C
98	5699809013M	5699827013C
0A	5690A09013M	5690A27013C
5A	5695A09013M	5695A27013C
6A	5696A09013M	5696A27013C
6B	5696B09013M	5696B27013C
7A	5697A09013M	5697A27013C
7B	5697B09013M	5697B27013C
8B	5698B09013M	5698B27013C
A4	569A409013M	569A427013C
A5	569A509013M	569A527013C
B1	569B109013M	569B127013C
B3	569B309013M	569B327013C
C9	569C909013M	569C927013C
D4	569D409013M	569D427013C
D5	569D509013M	569D527013C
D7	569D709013M	569D727013C
D9	569D909013M	569D927013C
E2	569E209013M	569E227013C
S5	569S509013M	569S527013C
S8	569S809013M	569S827013C
S9	569S909013M	569S927013C
T2	569T209013M	569T227013C
T3	569T309013M	569T327013C
Z3	569Z309013M	569Z327013C
€/u	11,80	33,20

521 Junta / T-motion / Joint de dilatation H: 5-24 mm



strong

H: 5-9 mm



ALUM. 03	5210327013C
//// ALUM. 03 E ////	6410327013C
ALUM. 04	5210427013C
ALUM. 05	5210527013C
€/u	28,05
ALUM. 07	5210727013C
ALUM. 25	5212527013C
//// ALUM. 25 E ////	6412527013C
€/u	33,15
11	5211127013C
12	5211227013C
13	5211327013C
33	5213327013C
73	5217327013C
S5	521S527013C
€/u	33,19

601 Junta / T-motion / Joint de dilatation H: 5-24 mm

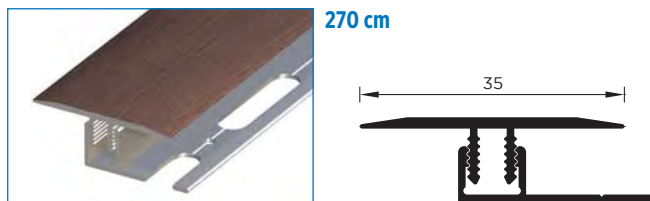

slim

H: 5-9 mm



ALUM. 03	6010327013C
€/u	27,27
11	6011127013C
12	6011227013C
13	6011327013C
33	6013327013C
73	6017327013C
S5	601S527013C
€/u	33,11

581 Junta / T-motion / Joint de dilatation

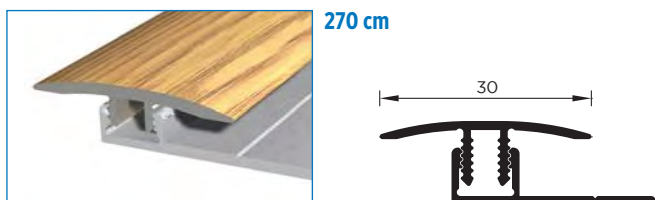

narrow

H: 5-9 mm



11	5811127013C
12	5811227013C
13	5811327013C
33	5813327013C
73	5817327013C
S5	581S527013C
€/u	32,60

592 Transición / Transition-ramp / Transition

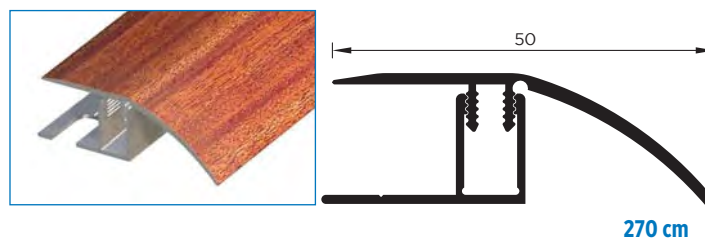

parquet

H: 12-17 mm



ALUM. 03	5920327013C
€/u	29,11
ALUM. 25	5922527013C
€/u	34,19
11	5921127013C
12	5921227013C
13	5921327013C
33	5923327013C
73	5927327013C
S5	592S527013C
€/u	36,91

5D1 Remate final / End profile / Bordure

H: 7-8 mm



270 cm

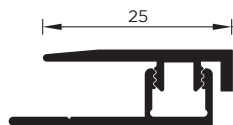

H: 7-8 mm



ALUM. 03	5D10327013C
€/u	27,06
11	5D1127013C
12	5D11227013C
13	5D11327013C
33	5D13327013C
73	5D17327013C
S5	5D1S527013C
€/u	32,58

541 Remate final / End profile / Bordure

H: 5-24 mm



270 cm

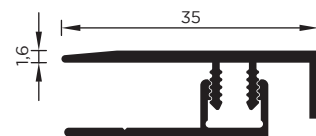

H: 5-9 mm



ALUM. 03	5410327013C
€/u	27,28
ALUM. 25	5412527013C
€/u	32,33
11	541127013C
12	5411227013C
13	5411327013C
33	5413327013C
73	5417327013C
S5	541S527013C
€/u	33,92

5E1 Transición / Transition-ramp / Transition

H: 6,5-9 mm



270 cm

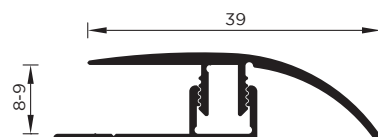

H: 8-9 mm



ALUM. 03	5E10327013C
//// ALUM. 03 E ///	6510327013C
€/u	28,06
11	5E1127013C
12	5E11227013C
13	5E11327013C
33	5E13327013C
73	5E17327013C
S5	5E1S527013C
€/u	33,20

571 Rinconera / Round corner / Cornière

H: 5-24 mm



270 cm



H: 5-9 mm



ALUM. 03	5710327013C
ALUM. 05	5710527013C
€/u	27,16
11	571127013C
12	5711227013C
13	5711327013C
33	5713327013C
73	5717327013C
S5	571S527013C
€/u	33,82



Consulte plazo y pedido mínimo
Please consult lead time and minimum order
Veuillez consulter les délais et la commande minimale



Cantoneras de escalera / Stair nosing / Nez de marche

551 H: 5-24 mm

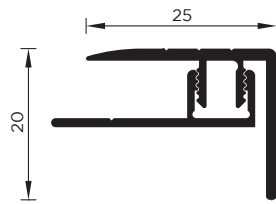
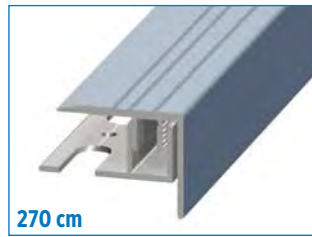

611 / 614 H: 5-24 mm

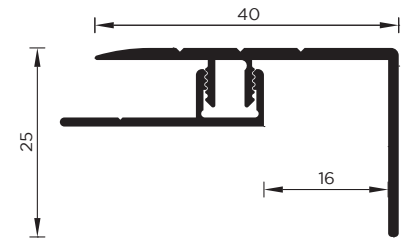
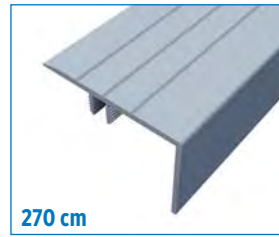

H: 5-9 mm



ALUM. 03	5510327013C
€/u	27,48
ALUM. 07	5510727013C
ALUM. 25	5512527013C
€/u	32,61

H: 5-9 mm

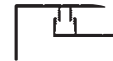

ALUM. 03	6110327013C	6140327013C
€/u	29,66	30,04
ALUM. 25	6112527013C	6142527013C
€/u	34,77	35,28

H: 9-13 mm

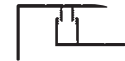

708 H: 8 mm

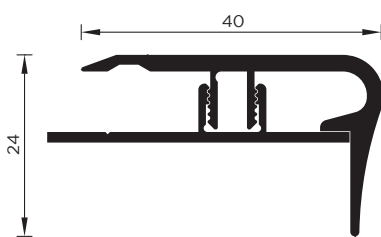
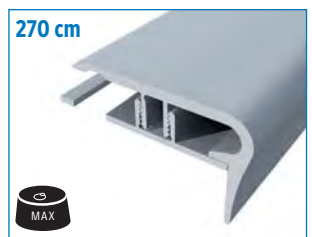

H: 8 mm



ALUM. 03	7080327013C
€/u	34,03

MULTIFIX SYSTEM - SYSTÈME À CLIPSER

aluminio - aluminium - aluminium

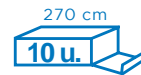

5AA Junta / T-motion / Joint de dilatation

270 cm

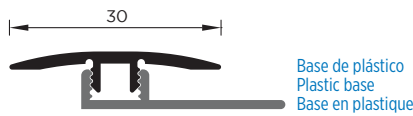

H: 3-4 mm



ALUM. 03	5AA0327000C
€/u	28,19
ALUM. 25	5AA2527000C
€/u	33,42
11	5AA1127000C
12	5AA1227000C
13	5AA1327000C
33	5AA3327000C
73	5AA7327000C
S5	5AAS527000C
€/u	30,86

5BA Junta / T-motion / Joint de dilatation

270 cm

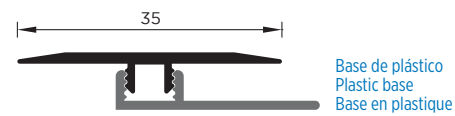

H: 3-5 mm



ALUM. 03	5BA0327000C
€/u	26,05
ALUM. 25	5BA2527000C
€/u	31,24
11	5BA1127000C
12	5BA1227000C
13	5BA1327000C
33	5BA3327000C
73	5BA7327000C
S5	5BAS527000C
€/u	30,86

5CA Transición / Transition-ramp / Transition

270 cm

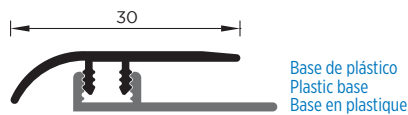

H: 3-5 mm



ALUM. 03	5CA0327000C
€/u	25,51
ALUM. 25	5CA2527000C
€/u	31,24
11	5CA1127000C
12	5CA1227000C
13	5CA1327000C
33	5CA3327000C
73	5CA7327000C
S5	5CAS527000C
€/u	30,86

5DA Remate final / End profile / Bordure

270 cm

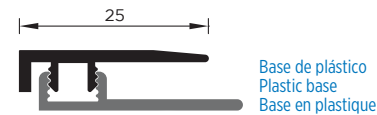

H: 3-5 mm



ALUM. 03	5DA0327000C
€/u	25,51
ALUM. 25	5DA2527000C
€/u	31,24
11	5DA1127000C
12	5DA1227000C
13	5DA1327000C
33	5DA3327000C
73	5DA7327000C
S5	5DAS527000C
€/u	30,86

5TC Albatross H: 0-9 mm

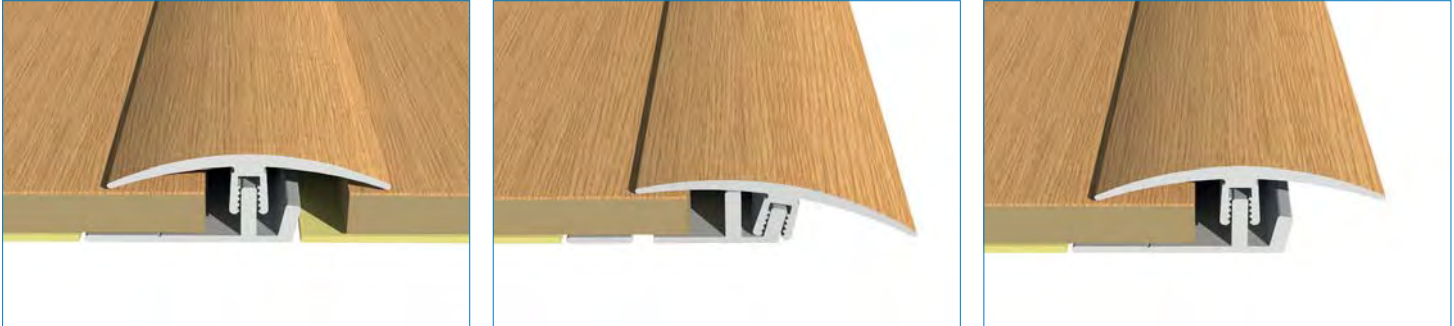

270 cm

ALBATROSS



NUEVO PERFIL MULTIFUNCIÓN
 NEW MULTIFUNCTIONAL PROFILE
 NOUVEAU PROFIL MULTIFONCTION

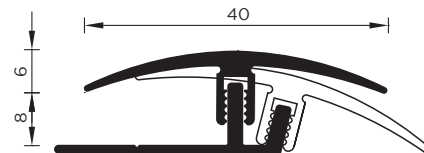

3 en 1
3 in 1
3-en-1

50 % menos de stock
 50 % less stock
 50 % moins de stock

JUNTA + TRANSICIÓN + REMATE
 SAME LEVEL + TRANSITION + END
 MÊME NIVEAU + RAMPE + BORDURE

	90 cm	270 cm
ALUM. 03	5TC0309013M	5TC0327013C
€/u	9,35	28,05
11	5TC1109013M	5TC1127013C
12	5TC1209013M	5TC1227013C
13	5TC1309013M	5TC1327013C
33	5TC3309013M	5TC3327013C
73	5TC7309013M	5TC7327013C
S5	5TCS509013M	5TCS527013C
€/u	11,07	33,19

Perfiles y bases / Profiles and bases / Profils et bases

Ref. 51
35 mm



Ref. 52
42 mm



Ref. 59
50 mm



Ref. 56
39 mm



Ref. 54
35 mm



Ref. 58
30 mm



Ref. 60
35 mm



Base 501
5-9 mm



Ref. 511



Ref. 521



Ref. 541



Ref. 581

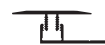

Ref. 601

Base 504
9-13 mm



Ref. 514



Ref. 524



Ref. 544



Ref. 584



Ref. 604

Base 502
12-17 mm



Ref. 512



Ref. 522



Ref. 592



Ref. 542



Ref. 582

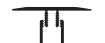

Ref. 602

Base 506
17-21 mm



Ref. 516



Ref. 526



Ref. 596



Ref. 546



Ref. 586



Ref. 606

Base 507
21-24 mm



Ref. 517



Ref. 527



Ref. 597



Ref. 547



Ref. 587



Ref. 607

Base 508
6-10 mm

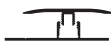

Ref. 518



Ref. 528



Ref. 588



Ref. 608

Base 505
3-5 mm



Ref. 585

Base 509
6-14 mm



Ref. 569

Base 50A
3-5 mm

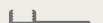

LVT

ESCALERAS / STAIRS / NEZ DE MARCHE

Ref. 5A
30 mm



Ref. 5B
35 mm



Ref. 5C
30 mm



Ref. 5D
25 mm



Ref. 57
30 mm



Ref. 55
25x20 mm



Ref. 70
40x24 mm



Ref. 61
40x25 mm

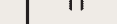

Ref. 5D1



Ref. 571



Ref. 551

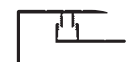

Ref. 611



Ref. 574



Ref. 554

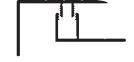

Ref. 614



Ref. 572



Ref. 552

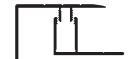

Ref. 612



Ref. 576



Ref. 556



Ref. 616



Ref. 577



Ref. 557



Ref. 617



Ref. 708



Ref. 5AA



Ref. 5BA



Ref. 5CA



Ref. 5DA

ESTÁNDAR
STANDARD
STANDARD

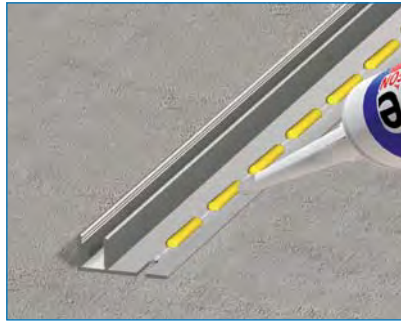

Base troquelada
Punched base
Base percée

LONG: 270 cm

5-9 mm 5011027013A 6,30 €/u.	9-13 mm 5041027013A 6,74 €/u.	12-17 mm 5021027013A 7,40 €/u.	17-21 mm 5061027013A 8,14 €/u.	21-24 mm 5071027013A 8,14 €/u.
BASE 1	BASE 4	BASE 2	BASE 6	BASE 7

ESPECIALES
SPECIAL BASES
BASES SPÉCIALES

6-10 mm 5081027013A 8,14 €/u.	3-5 mm 5051027013A 6,31 €/u. Con púas / Sin púas With prones / Without prones Avec pointes / Sans pointes	3-5 mm 5PA0027000A 3,46 €/u. Plástico / Plastic / Plastique Para suelos vinílicos For LVT Pour LVT
BASE 8	BASE 5	BASE A

6-14 mm (Ref. 56) 5091027013A 6,30 €/u.

BASE 9
Válida solo para **ref. 56**
Valid only for **ref. 56**
Valable seulement pour **réf. 56**

BASE 9

1

Fije la base al suelo con adhesivo de montaje. También puede ser atornillada si se desea.

Stick the base to the ground. It also can be screwed.

Collez la base au sol. Elle peut aussi être vissée.

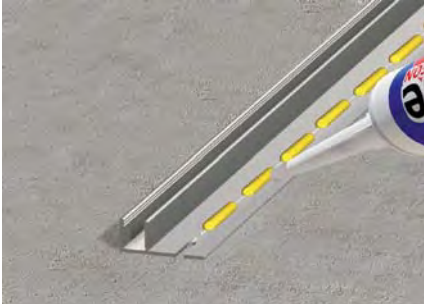

2

Coloque los paneles de laminado dejando un margen que permita la dilatación.

Place the laminate panels maintaining a margin with the profile to allow expansion.

Placez le sol stratifié et maintenez une marge avec le profil pour permettre la dilatation.

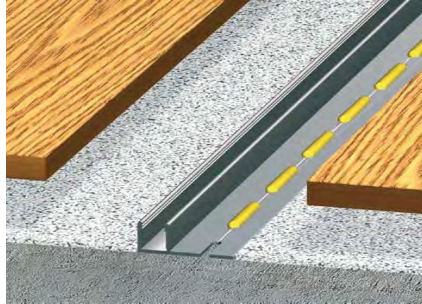

3

Coloque la parte superior sobre la base y presione.

Place the superior profile on top of the base and press.

Placez le profil supérieur sur la base et serrez.



4

Vista del perfil instalado.

View of the profile once installation ended.

Vue du profil, une fois l'assemblage fini.



Consejos de instalación

- En pasillos y habitaciones con una longitud o anchura superior a 10 m deben dejarse espacios de dilatación que irán cubiertos con el correspondiente perfil.
- Es obligatoria la instalación de elementos de dilatación en todos los pasos de puerta.

Installation tips

- Corridors and rooms wider or longer than 10 metres, must have dilatation spaces covered with profiles.
- It is compulsory the installation of expansion elements in all the doors or thresholds, covered with its relevant profile.

Conseils d'installation

- On doit laisser des espaces de dilatation, recouverts du profil correspondant, dans les chambres et couloirs d'une longueur/largeur supérieure à 10 mètres.
- Il est obligatoire d'installer des éléments de dilatation dans tous les seuils de porte.

PERFILES ESTRIADOS - RIBBED TOP PROFILES - PROFILS STRIÉS





SOLUCIONES DE ALUMINIO
ALUMINIUM SOLUTIONS
SOLUTIONS EN ALUMINIUM

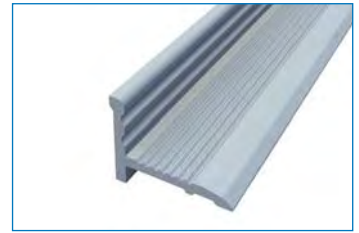
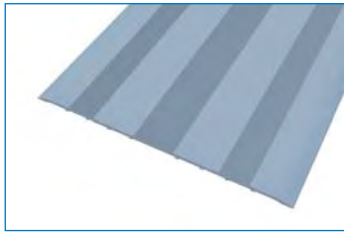
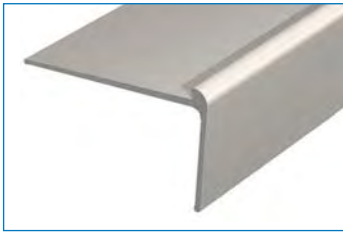



371
Adh.
20 mm

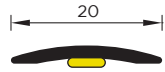

ALUM. 03	3710327001C
€/u	12,72
ALUM. 25	3712527001C
€/u	17,48

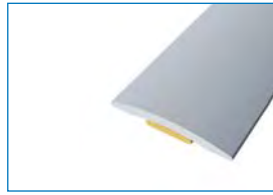

371
20 mm



ALUM. 03	3710327000C
€/u	10,12
ALUM. 25	3712527000C
€/u	14,77

303
Adh.
30 mm

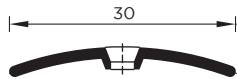

ALUM. 03	3030327012C
€/u	13,94

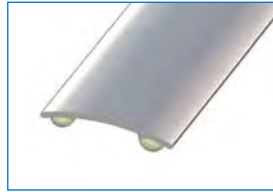

303
Adh.
30 mm



	90 cm	270 cm
ALUM. 03	3030309001T	3030327001C
ALUM. 04	3030409001T	3030427001C
ALUM. 05	3030509001T	3030527001C
€/u	5,22	14,51

375
Adh.
32 mm
Liso / Smooth /
Lisse

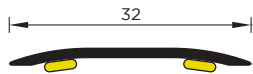

ALUM. 03	3750327001C
€/u	14,25
ALUM. 25	3752527001C
€/u	19,07

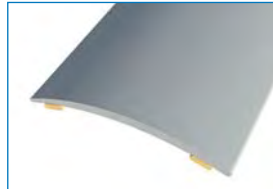

323
Adh.
40 mm
0-12 mm
Liso / Smooth /
Lisse
2 en 1 / 2 in 1

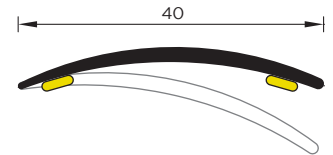

ALUM. 03	3230327001C
€/u	14,78
ALUM. 25	3232527001C
€/u	19,58

309
Adh.
40 mm
Estriado /
Ribbed top / Strié

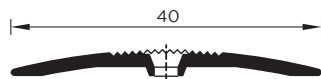

	83 cm	270 cm
//// ALUM. 03 E ///	3090308312T	3090327012C
//// ALUM. 04 E ///	3090408312T	3090427012C
//// ALUM. 05 E ///	3090508312T	3090527012C
€/u	5,36	16,56

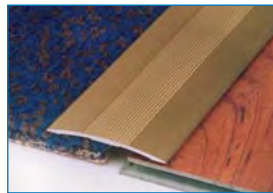

309
Adh.
40 mm
Estriado /
Ribbed top / Strié

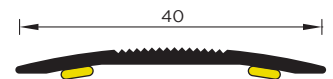

	83 cm	270 cm
//// ALUM. 03 E ///	3090308301T	3090327001C
//// ALUM. 04 E ///	3090408301T	3090427001C
//// ALUM. 05 E ///	3090508301T	3090527001C
€/u	5,08	17,52



382
Adh.
38 mm

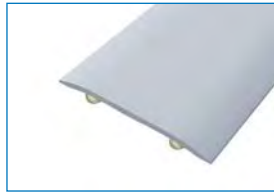
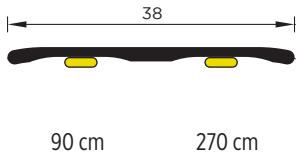

ALUM. 03	3820309001B	3820327001C
ALUM. 04	3820409001B	3820427001C
€/u	5,11	14,26
ALUM. 07	3820709001B	3820727001C
€/u	6,72	19,35



Consulte plazo y pedido mínimo
Please consult lead time and minimum order
Veuillez consulter les délais et la commande minimale

370
Adh.
37 mm



ALUM. 03	3700309001B	3700327001C
ALUM. 04	3700409001B	3700427001C
ALUM. 05	3700509001B	3700527001C
€/u	5,11	14,51
ALUM. 07	3700709001B	3700727001C
ALUM. 25	3702509001B	3702527001C
€/u	6,72	19,35

Perfiles anchos / Wide profiles / Profils larges

362

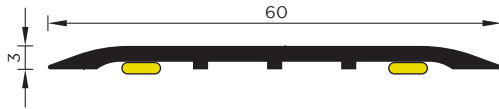

ALUM. 03	3620327001C	30,19 €/u
----------	-------------	-----------

394



Ref. V750000020

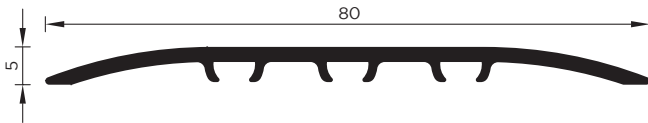

fijación invisible - invisible fixation - fixation invisible

ALUM. 03	3940327000F	38,03 €/u
----------	-------------	-----------

394



Ref. V750000020

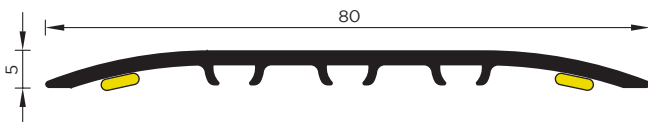

fijación invisible - invisible fixation - fixation invisible

ALUM. 03	3940327001F	39,35 €/u
----------	-------------	-----------

397

NEW!
NUEVO
NOUVEAU

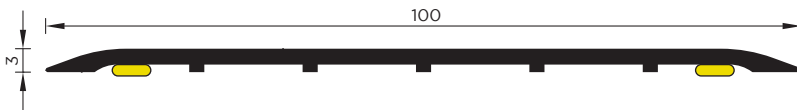

ALUM. 03	3970327001C	55,28 €/u
----------	-------------	-----------

339

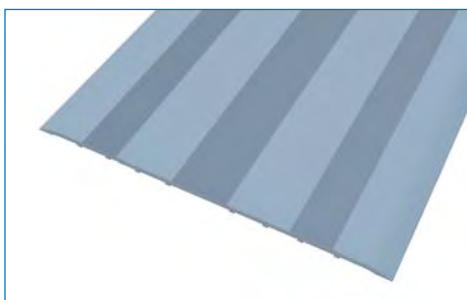
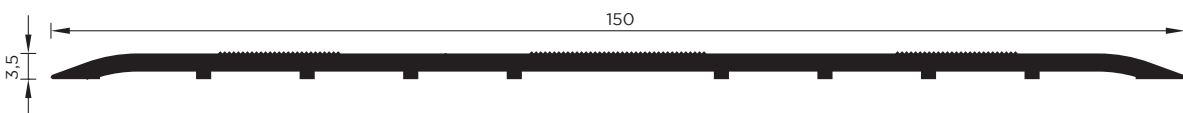

//// ALUM. 03 E ////	3390327000C	63,91 €/u
----------------------	-------------	-----------



Ref. V750000104

Broca + broca avellanadora / Drill bit + Countersink drill bit / Fraise d'encastrement de têtes de vis + mèche

15,75 €/u

315

Adh.

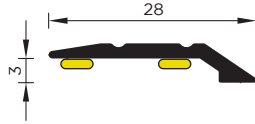

ALUM. 03	3150327001C
€/u	16,45
ALUM. 25	3152527001C
€/u	21,32



317

Adh.

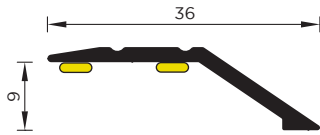

ALUM. 03	3170327001C
€/u	17,78

? Consulte plazo y pedido mínimo
 Please consult lead time and minimum order
 Veuillez consulter les délais et la commande minimale

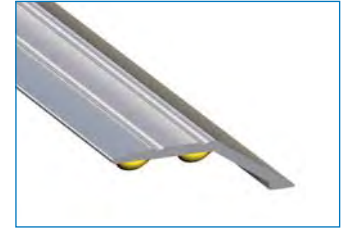

310

Adh.

NEW!
 NUEVO
 NOUVEAU

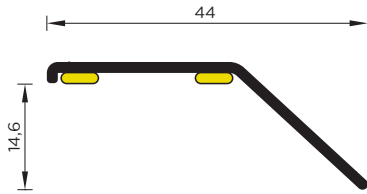

ALUM. 03	3100327001C
€/u	20,47

? Consulte plazo y pedido mínimo
 Please consult lead time and minimum order
 Veuillez consulter les délais et la commande minimale

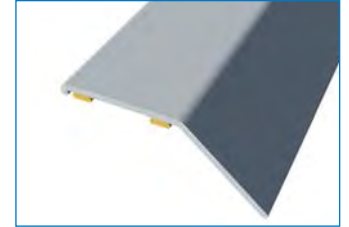

383

Adh.
 8-15 mm

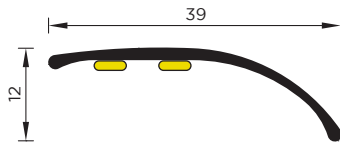

ALUM. 03	3830327001C
€/u	14,26
ALUM. 07	3830727001C
€/u	19,35

? Consulte plazo y pedido mínimo
 Please consult lead time and minimum order
 Veuillez consulter les délais et la commande minimale

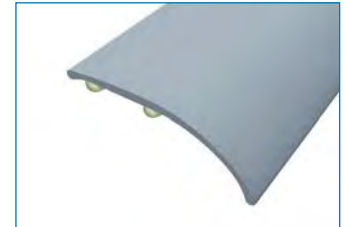

323

Adh.
 40 mm
 0-12 mm
 2 en 1 / 2 in 1

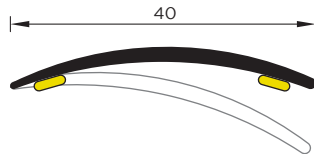

ALUM. 03	3230327001C
€/u	14,78
ALUM. 25	3232527001C
€/u	19,58

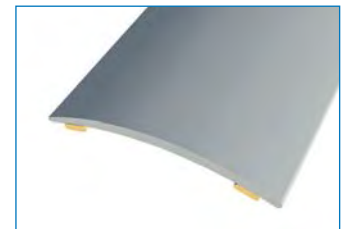

332

Adh.
 7-14 mm

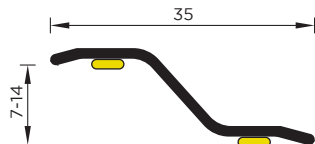

ALUM. 03	3320327001C
€/u	14,51

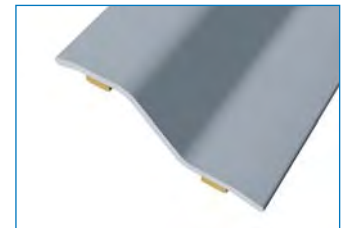

331

Adh.
 7-14 mm

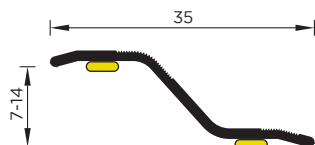

//// ALUM. 03 E ////	3310327001C
//// ALUM. 04 E ////	3310427001C
€/u	19,90



385 3-8 mm



ALUM. 03	385032700C	23,92 €/u
----------	------------	-----------

385 Adh. 3-8 mm



ALUM. 03	385032701C	24,47 €/u
----------	------------	-----------

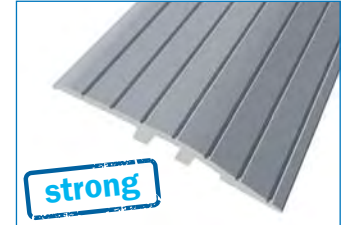

384 4-8 mm 

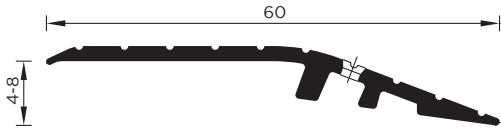

ALUM. 03	3840327012C	
€/u		30,45

384 4-8 mm **384 Adh.** 4-8 mm

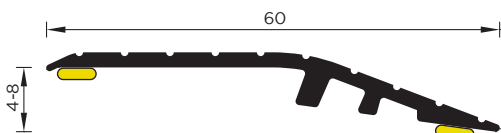

ALUM. 03	3840327000C	3840327001C
€/u	29,63	30,19



381

strong

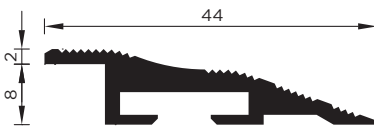

//// ALUM. 03 E ////	3810327000C	
€/u		40,59

Alta resistencia - High resistance - Haute résistance



Cubrecables / Cable covering / Couvre-câbles

353

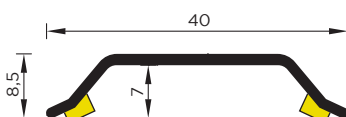

ALUM. 03	3530327001C	18,65 €/u
ALUM. 04	3530427001C	18,65 €/u
ALUM. 05	3530527001C	18,65 €/u



Consulte plazo y pedido mínimo
Please consult lead time and minimum order
Veuillez consulter les délais et la commande minimale

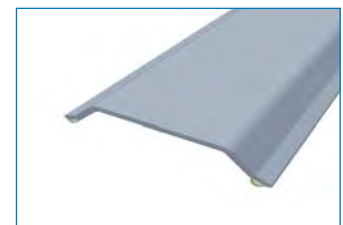

Perfil T / T profile / Profil T

270 cm

345

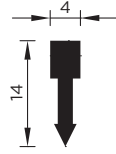

ALUM. 03	3450327000E	10,21 €/u
ALUM. 04	3450427000E	10,21 €/u
ALUM. 05	3450527000E	10,21 €/u

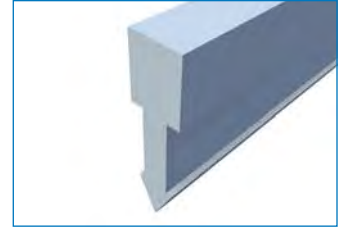

320

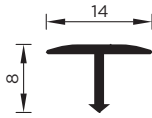

ALUM. 03	3200327000E	6,37 €/u
ALUM. 04	3200427000E	6,37 €/u
ALUM. 05	3200527000E	6,37 €/u

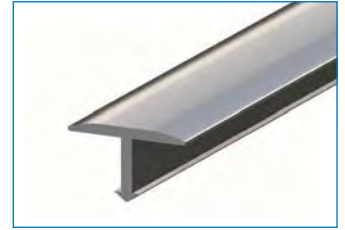

361

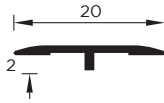

ALUM. 03	3610327000E	10,21 €/u
----------	-------------	-----------

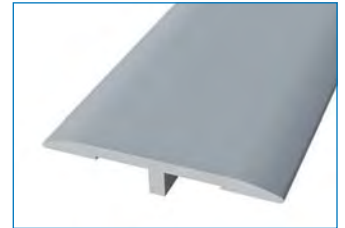

346

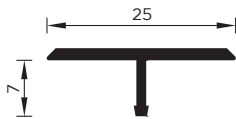

ALUM. 03	3460327000E	10,82 €/u
ALUM. 04	3460427000E	10,82 €/u
ALUM. 05	3460527000E	10,82 €/u

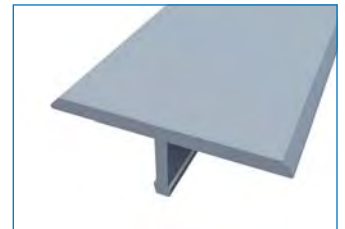

360

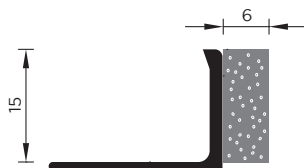

ALUM. 10	3601027054E	11,20 €/u
----------	-------------	-----------

Espuma color negro
Black colour foam
Mousse couleur noir

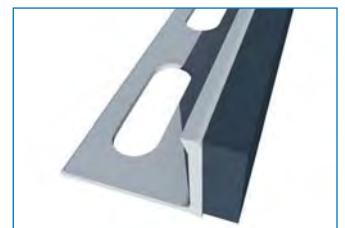

Remate / End profile / Bordure

270 cm

369

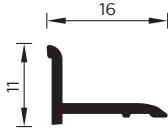

ALUM. 03	3690327000E	10,52 €/u
ALUM. 25	3692527000E	15,20 €/u
LAQ. - LB	369LB27000E	10,52 €/u

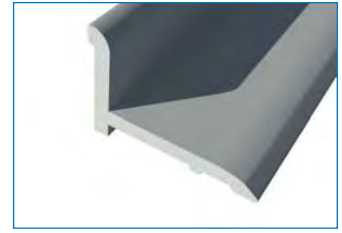

347

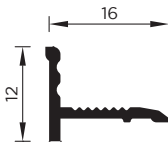

ALUM. 03	3470327000E	10,52 €/u
ALUM. 25	3472527000E	15,20 €/u
LAQ. - LB	347LB27000E	10,52 €/u



359

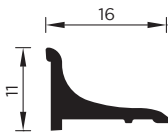

ALUM. 03	3590327000E	12,12 €/u
ALUM. 25	3592527000E	16,86 €/u
LAQ. - LB	359LB27000E	12,12 €/u

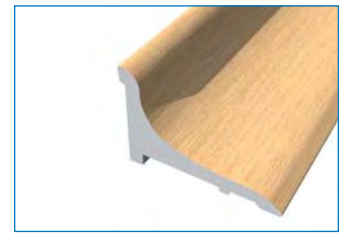

481

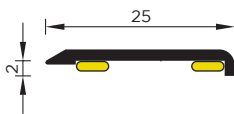

ALUM. 03	4810327001C	15,31 €/u
ALUM. 25	4812527001C	20,11 €/u
LAQ. - LB	481LB27001C	15,31 €/u



426

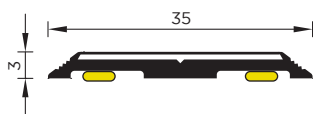

ALUM. 03	4260327051C	26,55 €/u
----------	-------------	-----------

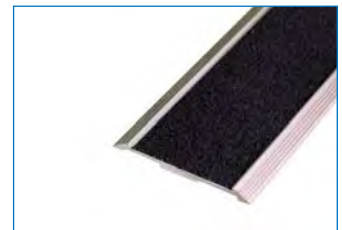

427

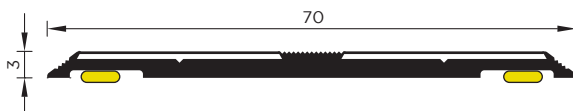

ALUM. 03	4270327051C	45,40 €/u
----------	-------------	-----------



Remate / End profile / Bordure

270 cm

341

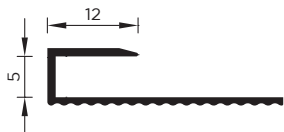

ALUM. 03	3410327000E	18,03 €/u
ALUM. 04	3410427000E	18,03 €/u
ALUM. 05	3410527000E	18,03 €/u
ALUM. 25	3412527000E	23,03 €/u

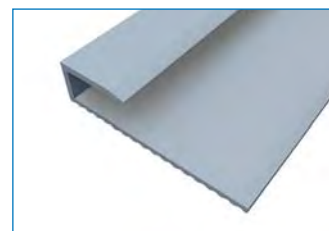

338

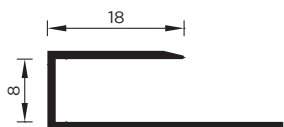

ALUM. 03	3380327000E	19,12 €/u
ALUM. 04	3380427000E	19,12 €/u
ALUM. 07	3380727000E	24,33 €/u
ALUM. 25	3382527000E	24,33 €/u
11	3381127000E	25,18 €/u
12	3381227000E	25,18 €/u
13	3381327000E	25,18 €/u

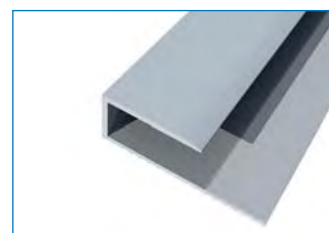

348

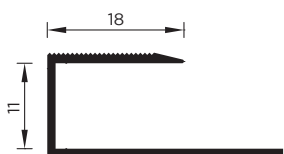

//// ALUM. 03 E ////	3480327000E	19,29 €/u
//// ALUM. 04 E ////	3480427000E	19,29 €/u
//// ALUM. 25 E ////	3482527000E	23,93 €/u

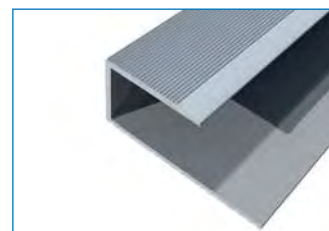

399

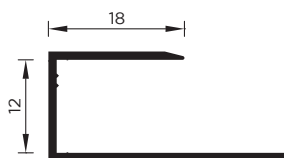

ALUM. 03	3990327000E	20,02 €/u
----------	-------------	-----------

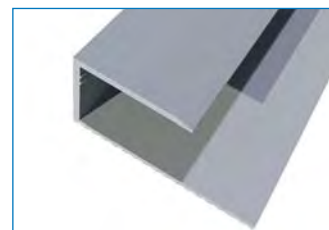

396

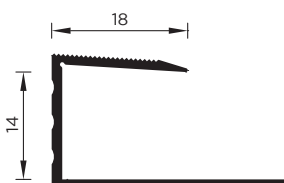

//// ALUM. 03 E ////	3960327000E	20,75 €/u
//// ALUM. 04 E ////	3960427000E	20,75 €/u



Junta / Joint / Joint 270 cm

340

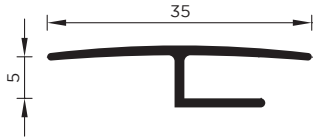

ALUM. 03	3400327000E	18,65 €/u
ALUM. 04	3400427000E	18,65 €/u

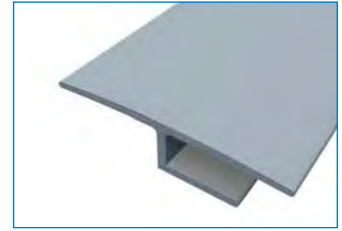

327

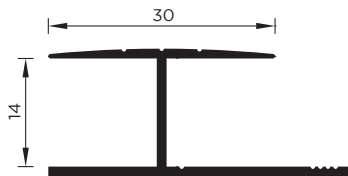

ALUM. 03	3270327000E	25,25 €/u
ALUM. 04	3270427000E	25,25 €/u



Consulte plazo y pedido mínimo
Please consult lead time and minimum order
Veuillez consulter les délais et la commande minimale

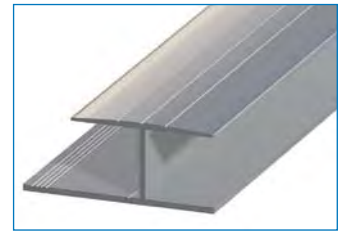

30A

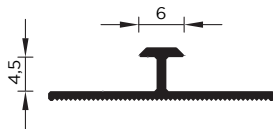

ALUM. 03	30A0327000E	13,09 €/u
----------	-------------	-----------

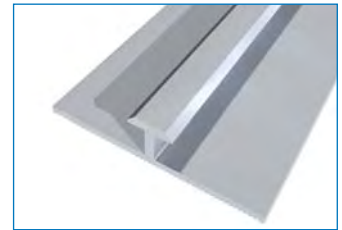

Transición / Ramp / Rampe 270 cm

335

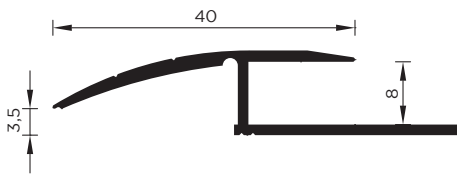

ALUM. 03	3350327000E	27,44 €/u
ALUM. 04	3350427000E	27,44 €/u
ALUM. 05	3350527000E	27,44 €/u



Consulte plazo y pedido mínimo
Please consult lead time and minimum order
Veuillez consulter les délais et la commande minimale

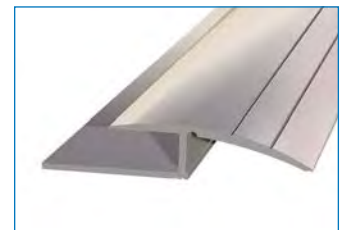

325

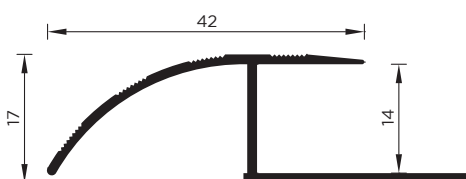

//// ALUM. 03 E ////	3250327000E	28,24 €/u
//// ALUM. 04 E ////	3250427000E	28,24 €/u



Consulte plazo y pedido mínimo
Please consult lead time and minimum order
Veuillez consulter les délais et la commande minimale



Remate / End profile / Bordure

270 cm

318

3 mm

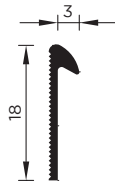

ALUM. 03	3180327000E	9,73 €/u
ALUM. 07	3180727000E	14,49 €/u

322

4 mm

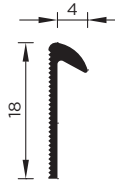

ALUM. 03	3220327000E	9,74 €/u
----------	-------------	----------

324

5 mm

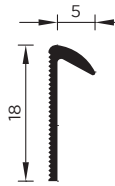

ALUM. 03	3240327000E	10,39 €/u
----------	-------------	-----------

319

2 mm

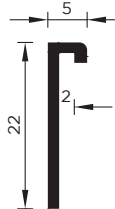

ALUM. 03	3190327000E	10,82 €/u
----------	-------------	-----------

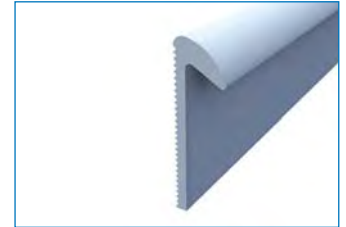

Escaleras / Stairs / Escaliers

300 cm

344

5 mm

LVT

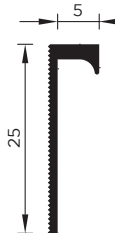

3440327000E	10,94 €/u
-------------	-----------

343

5 mm

LVT

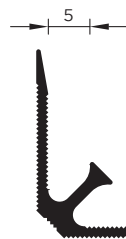

3430330000E	22,41 €/u
-------------	-----------

342

5 mm

LVT

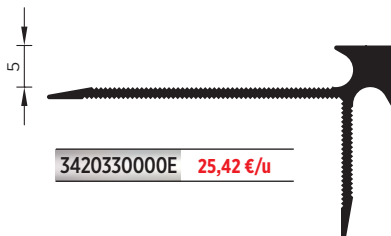

3420330000E	25,42 €/u
-------------	-----------

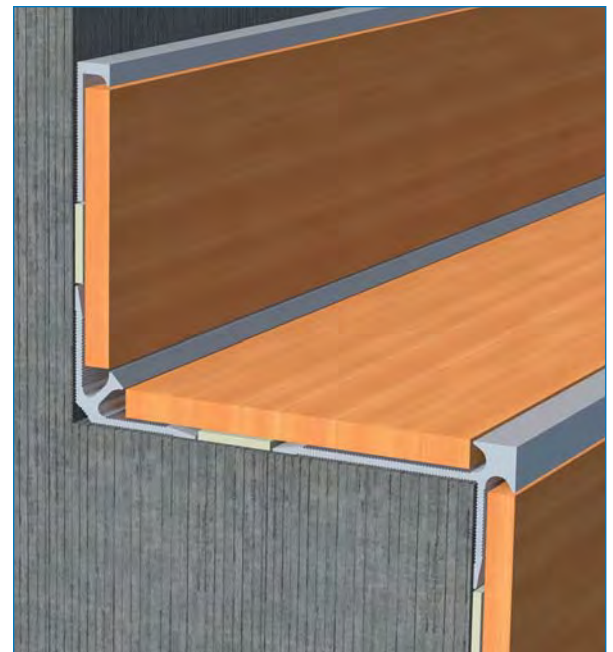

270/300 cm
10 u.

% % % Solicite precio para cantidades
Ask quotation linked to quantities
Consultez les prix liés aux quantités

E Granel Bulk Vrac Pg. 78-79*

484
2,5 mm

357
3,5 mm

342
5 mm

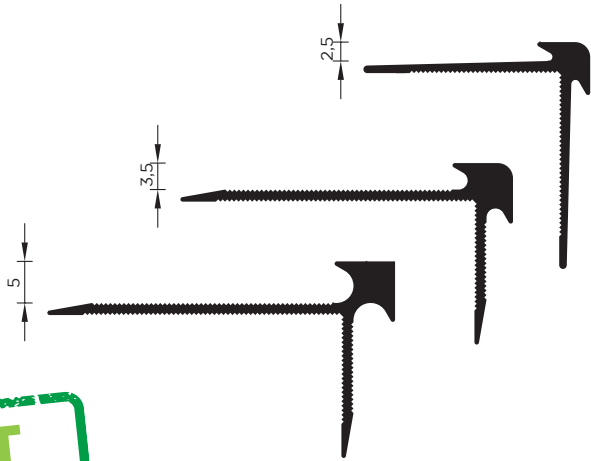

ALUM. 03	4840330000E	25,42 €/u
----------	-------------	-----------

ALUM. 03	3570330000E	25,42 €/u
----------	-------------	-----------

ALUM. 03	3420330000E	25,42 €/u
----------	-------------	-----------

Remate / End profile / Bordure

270 cm

363
2,5 mm



ALUM. 03	3630327000E	18,02 €/u
----------	-------------	-----------

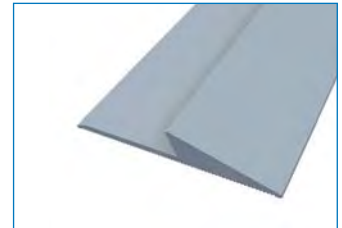

354
5 mm

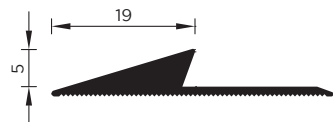

ALUM. 03	3540327000E	18,02 €/u
----------	-------------	-----------

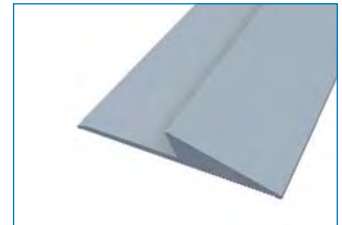

355

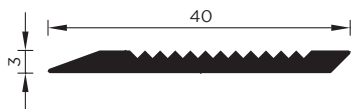

ALUM. 03	3550327000E	21,63 €/u
----------	-------------	-----------



Consulte plazo y pedido mínimo
Please consult lead time and minimum order
Veuillez consulter les délais et la commande minimale

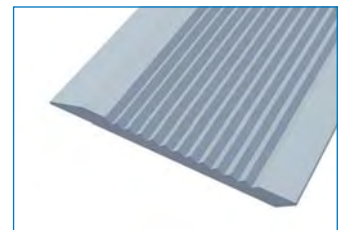
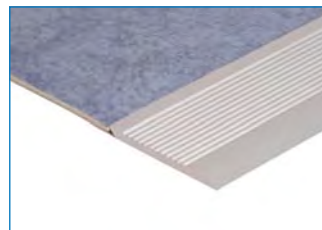

386

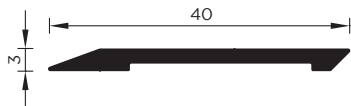

ALUM. 03	3860327000E	21,63 €/u
----------	-------------	-----------

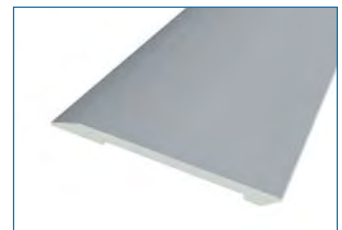

481

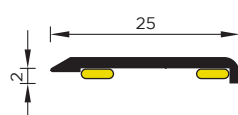

ALUM. 03	4810327001C	15,31 €/u
LAQ. - LB	481LB27001C	15,31 €/u
ALUM. 25	4812527001C	20,11 €/u

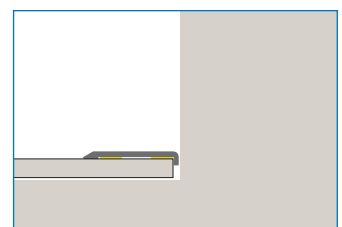
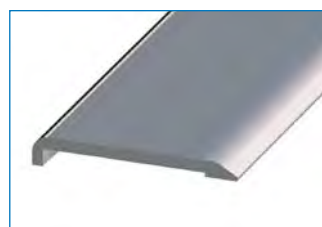

Mismo - diferente nivel / Same - different level / Même - différent niveau (2-en-1)

389

0-12 mm

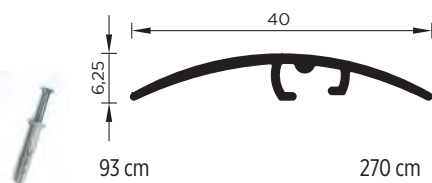

NEW!
NUEVO
NOUVEAU

ALUM. 03	3890309300F	3890327000F
ALUM. 04	3890409300F	3890427000F
ALUM. 05	3890509300F	3890527000F
€/u	7,45	20,99

ALUM. 07	3890709300F	3890727000F
ALUM. 25	3892509300F	3892527000F
€/u	9,14	25,80

70	3897009300F	3897027000F
73	3897309300F	3897327000F
84	3898409300F	3898427000F
87	3898709300F	3898727000F
D4	389D409300F	389D427000F
D6	389D609300F	389D627000F
S9	389S909300F	389S927000F
€/u	9,28	26,41

389

Adhésif
0-12 mm

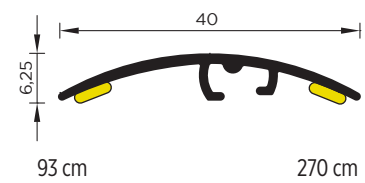

NEW!
NUEVO
NOUVEAU

ALUM. 03	3890309301F	3890327001F
ALUM. 04	3890409301F	3890427001F
ALUM. 05	3890509301F	3890527001F
€/u	8,85	24,95

ALUM. 07	3890709301F	3890727001F
ALUM. 25	3892509301F	3892527001F
€/u	10,62	29,95

70	3897009301F	3897027001F
73	3897309301F	3897327001F
84	3898409301F	3898427001F
87	3898709301F	3898727001F
D4	389D409301F	389D427001F
D6	389D609301F	389D627001F
S9	389S909301F	389S927001F
€/u	10,52	29,86

387

0-12 mm

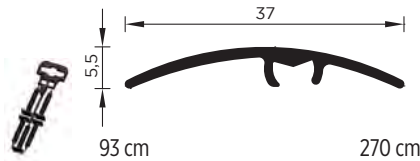

ALUM. 03	3870309300F	3870327000F
ALUM. 04	3870409300F	3870427000F
ALUM. 05	3870509300F	3870527000F
€/u	6,81	19,39

ALUM. 07	3870709300F	3870727000F
ALUM. 25	3872509300F	3872527000F
€/u	8,49	23,89

70	3877009300F	3877027000F
€/u	8,73	25,02

387

Adhesivo
Adhesive
Adhésif
0-12 mm

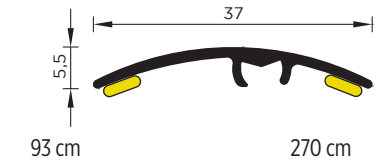

ALUM. 03	3870309301F	3870327001F
ALUM. 04	3870409301F	3870427001F
ALUM. 05	3870509301F	3870527001F
€/u	8,20	23,10

ALUM. 07	3870709301F	3870727001F
ALUM. 25	3872509301F	3872527001F
€/u	9,98	27,77

70	3877009301F	3877027001F
€/u	9,96	28,23

388

0-17 mm

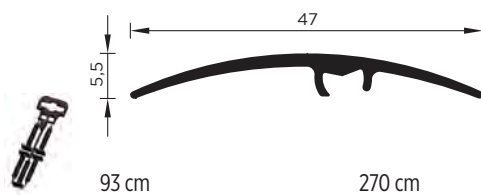

ALUM. 03	3880309300F	3880327000F
ALUM. 04	3880409300F	3880427000F
ALUM. 05	3880509300F	3880527000F
€/u	8,08	22,58

ALUM. 07	3880709300F	3880727000F
ALUM. 25	3882509300F	3882527000F
€/u	9,79	27,71

70	3887009300F	3887027000F
73	3887309300F	3887327000F
84	3888409300F	3888427000F
87	3888709300F	3888727000F
D4	388D409300F	388D427000F
D6	388D609300F	388D627000F
S9	388S909300F	388S927000F
€/u	9,83	27,79

388

Adhesivo
Adhesive
Adhésif
0-17 mm

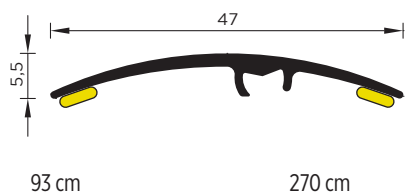

ALUM. 03	3880309301F	3880327001F
ALUM. 04	3880409301F	3880427001F
ALUM. 05	3880509301F	3880527001F
€/u	9,50	26,80

ALUM. 07	3880709301F	3880727001F
ALUM. 25	3882509301F	3882527001F
€/u	11,26	32,12

70	3887009301F	3887027001F
73	3887309301F	3887327001F
84	3888409301F	3888427001F
87	3888709301F	3888727001F
D4	388D409301F	388D427001F
D6	388D609301F	388D627001F
S9	388S909301F	388S927001F
€/u	11,07	31,48

Moqueta / Carpet / Moquette

270 cm

311

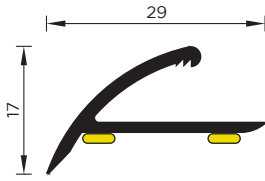

ALUM. 03	3110327001C	21,44 €/u
ALUM. 04	3110427001C	21,44 €/u
ALUM. 05	3110527001C	21,44 €/u

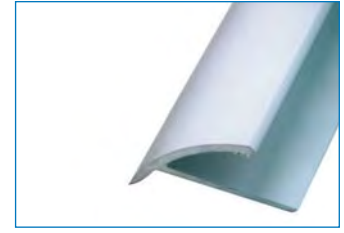

313

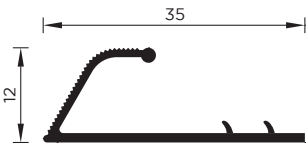

//// ALUM. 03 E ////	3130327015E	20,88 €/u
//// ALUM. 04 E ////	3130427015E	20,88 €/u
//// ALUM. 05 E ////	3130527015E	20,88 €/u

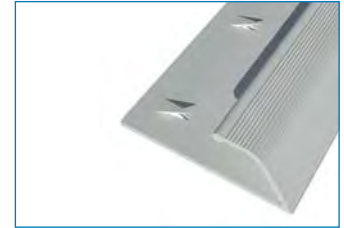

Consulte plazo y pedido mínimo
Please consult lead time and minimum order
Veuillez consulter les délais et la commande minimale

304

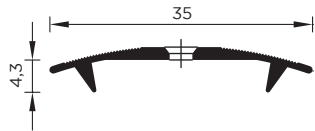

//// ALUM. 03 E ////	3040327012E	15,63 €/u
//// ALUM. 04 E ////	3040427012E	15,63 €/u



312

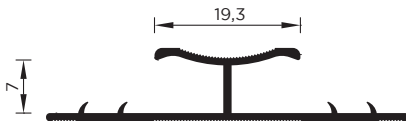

//// ALUM. 03 E ////	3120327015E	30,30 €/u
//// ALUM. 04 E ////	3120427015E	30,30 €/u
//// ALUM. 05 E ////	3120527015E	30,30 €/u

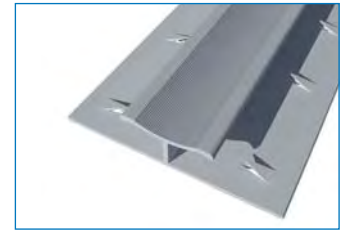

Consulte plazo y pedido mínimo
Please consult lead time and minimum order
Veuillez consulter les délais et la commande minimale

316

NEW!
NUEVO
NOUVEAU

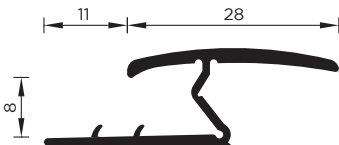

ALUM. 03	3160327015C	27,43 €/u
73	3167327015C	31,21 €/u



NEW!
NUEVO
NOUVEAU

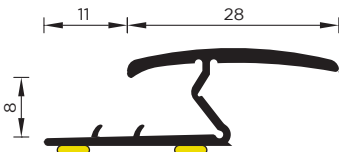

ALUM. 03	3160327016C	28,87 €/u
73	3167327016C	32,65 €/u



488
300 cm

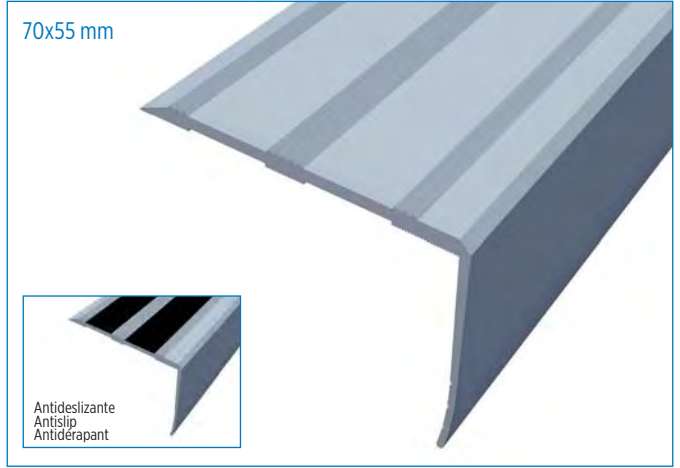
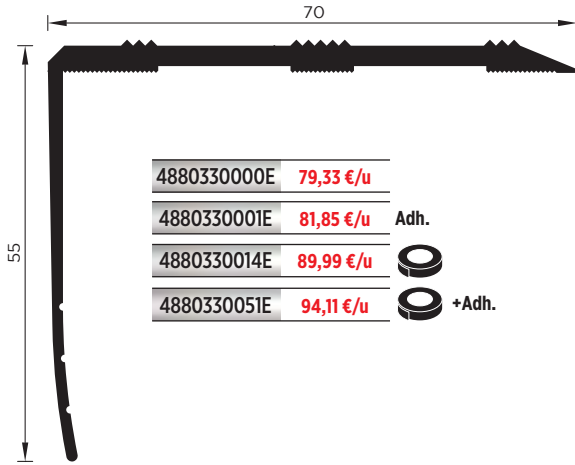

438

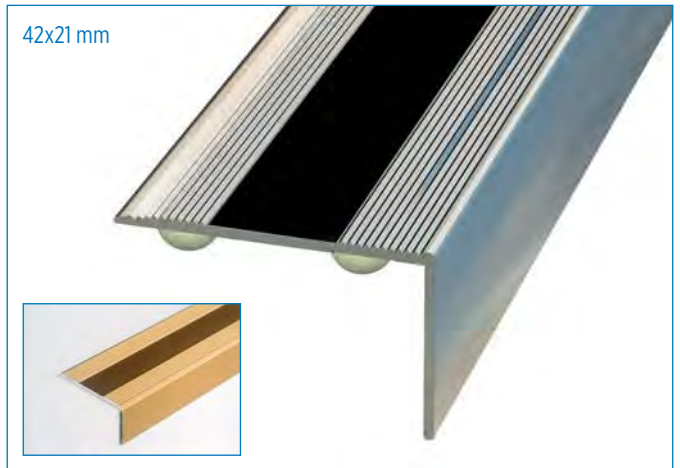
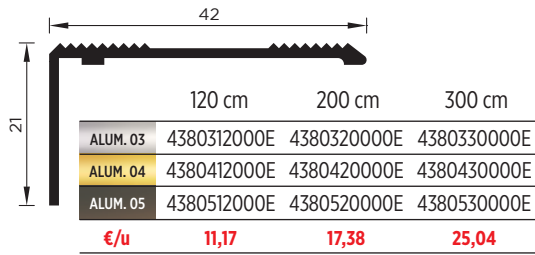

438

Adh.

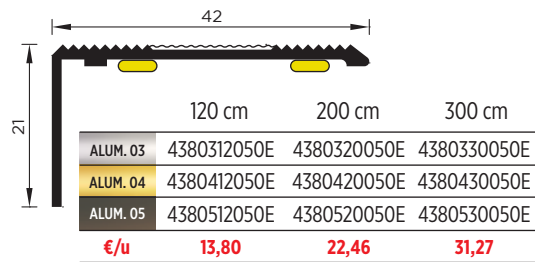

438

Adh.

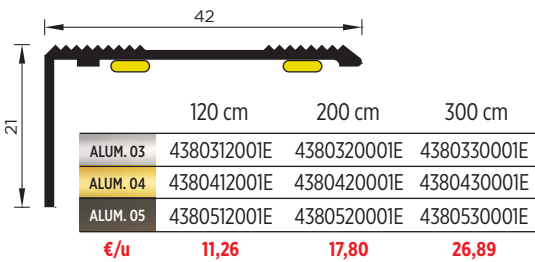

489

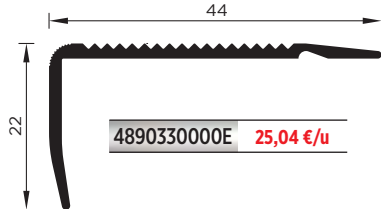

489

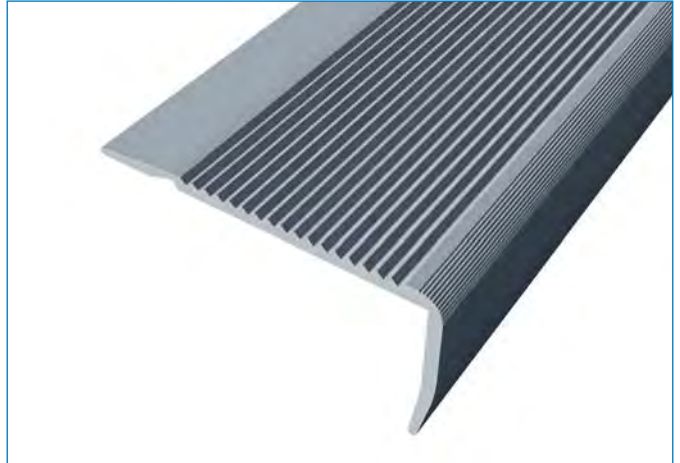
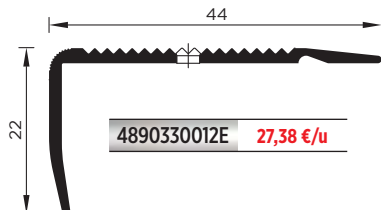

200/300 cm



E Granel Bulk Vrac Pg. 78-79*

ALUMINIUM SOLUTIONS - SOLUTIONS EN ALUMINIUM

cantoneras - stair nosing - nez de marche

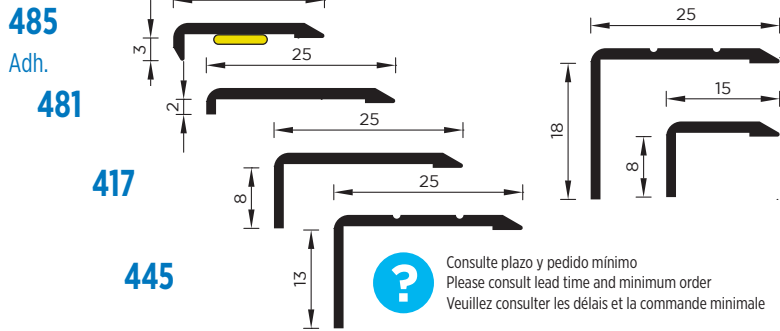

? Consulte plazo y pedido mínimo
Please consult lead time and minimum order
Veuillez consulter les délais et la commande minimale

Ref.	Adh.	Adh.				
Ref. 485	-	-	4850327001C	12,72 €/u	-	-
Ref. 481	4810327000C	10,43 €/u	4810327001C	15,31 €/u	-	-
Ref. 417	4170327000C	12,83 €/u	4170327001C	15,69 €/u	-	-
Ref. 445	4450327000C	15,05 €/u	4450327001C	17,62 €/u	4450327012C	17,36 €/u
Ref. 415	4150327000C	17,64 €/u	4150327001C	19,97 €/u	4150327012C	19,35 €/u
Ref. 483	4830327000C	10,96 €/u	-	-	-	-

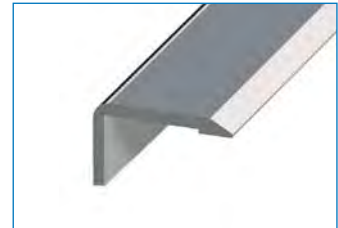
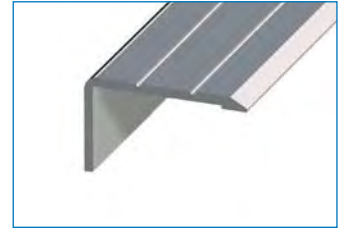

458

Adh.
300 cm



Incluido
Included
Inclus
Adherido
Stuck
Collé

458

300 cm



Incluido
Included
Inclus
No adherido
Non stuck
Pas collé

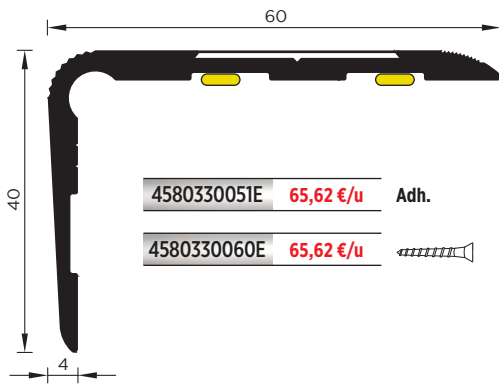

4580330051E	65,62 €/u	Adh.
4580330060E	65,62 €/u	

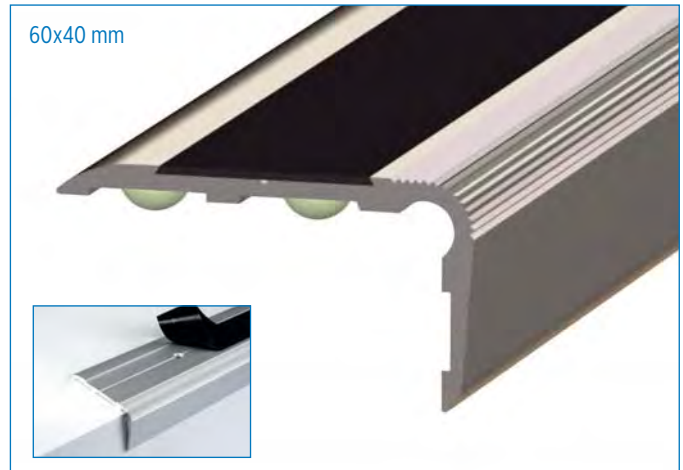

418

Adh.



Incluido
Included
Inclus
Adherido
Glued
Collé

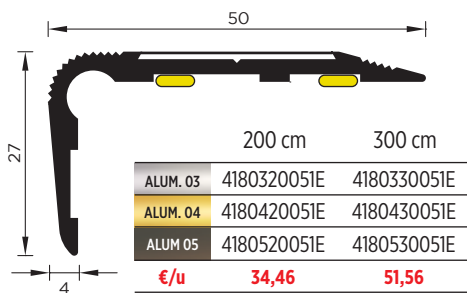

	200 cm	300 cm
ALUM. 03	4180320051E	4180330051E
ALUM. 04	4180420051E	4180430051E
ALUM. 05	4180520051E	4180530051E
	€/u	34,46
		51,56

418



Incluido
Included
Inclus
No adherido
Non glued
Pas collé

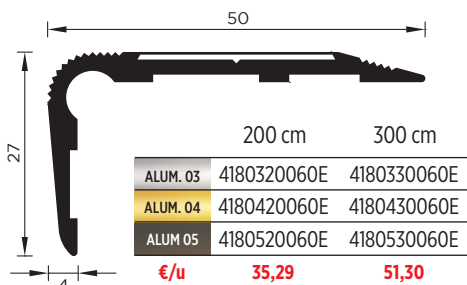

	200 cm	300 cm
ALUM. 03	4180320060E	4180330060E
ALUM. 04	4180420060E	4180430060E
ALUM. 05	4180520060E	4180530060E
	€/u	35,29
		51,30

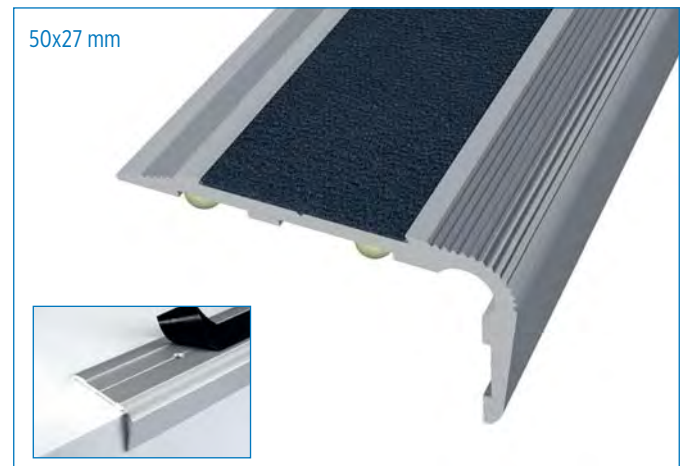

486



Incluido
Included
Inclus
Adherido
Glued
Collé

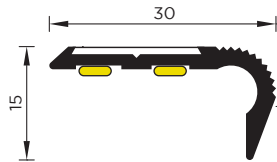

4860330051E 29,29 €/u

486



Incluido
Included
Inclus
No adherido
Non glued
Pas collé

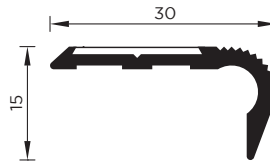

4860330060E 28,72 €/u

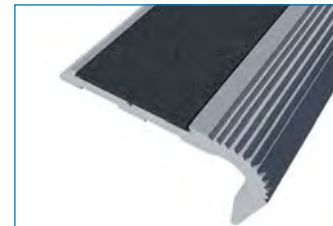

462

300 cm

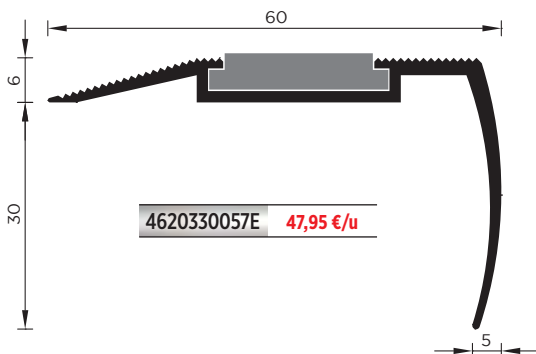

4620330057E 47,95 €/u



Consulte plazo y pedido mínimo
Please consult lead time and minimum order
Veuillez consulter les délais et la commande minimale

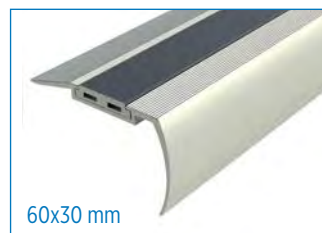

60x30 mm

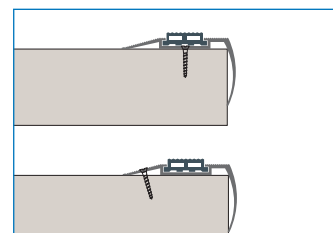

428

300 cm

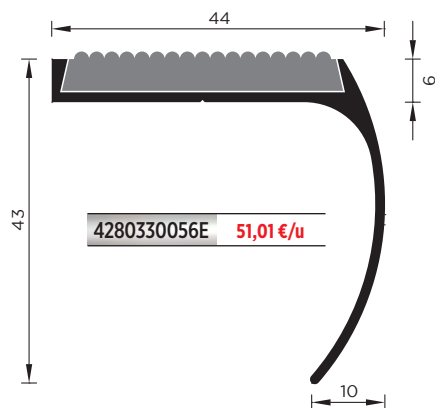

4280330056E 51,01 €/u

44x43 mm

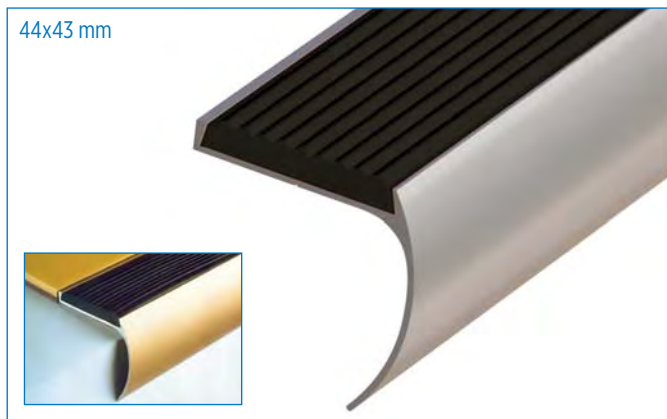

468

300 cm

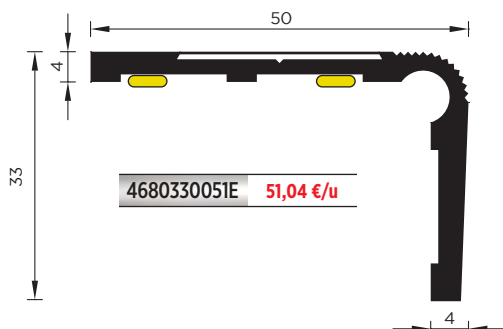

4680330051E 51,04 €/u

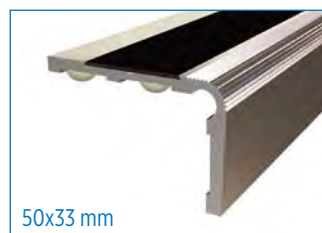

50x33 mm

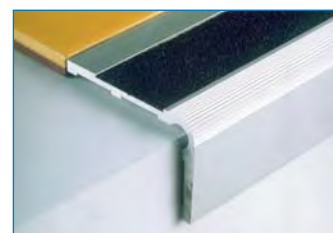

398

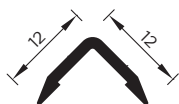

ALUM. 03	3980327000E	12,72 €/u
ALUM. 25	3982527000E	17,48 €/u
LAQ. - LB	398LB27000E	12,72 €/u



305

270 cm

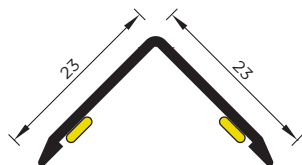

ALUM. 03	3050327001C	18,56 €/u
ALUM. 04	3050427001C	18,56 €/u
ALUM. 05	3050527001C	18,56 €/u
ALUM. 25	3052527001C	23,52 €/u

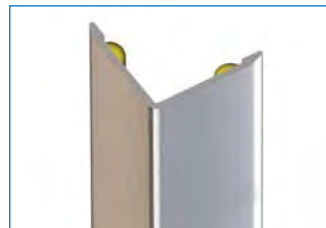

019

250 cm

INOX

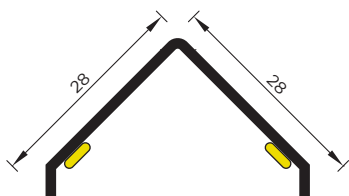

01	0190125001E	14,17 €/u
----	-------------	-----------



484

2,5 mm

357

3,5 mm

342

5 mm

465

2,8 mm

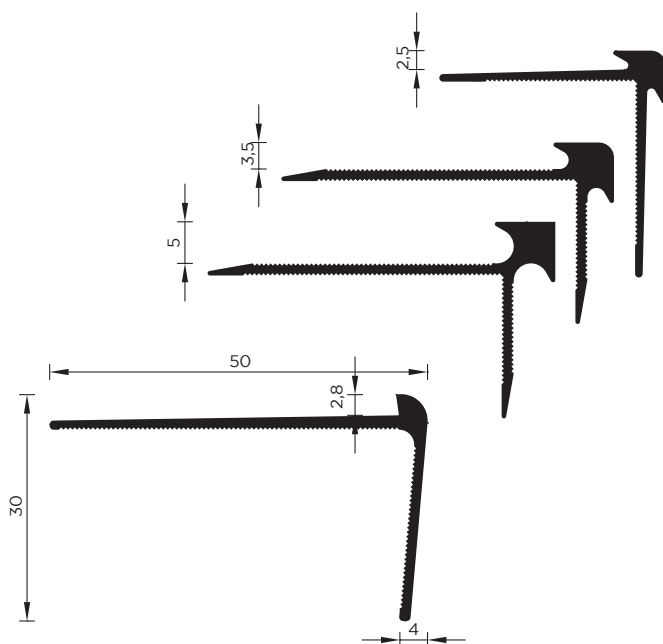

4840330000E	25,42 €/u
3570330000E	25,42 €/u
3420330000E	25,42 €/u
4650330000E	25,42 €/u

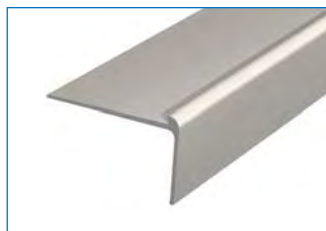
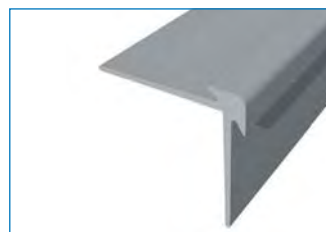

379

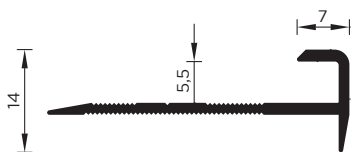

ALUM. 03	3790327000E	17,94 €/u
ALUM. 25	3792527000E	22,52 €/u

349

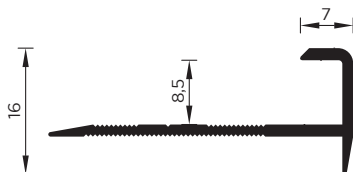

ALUM. 03	3490327000E	21,27 €/u
ALUM. 25	3492527000E	26,34 €/u
11	3491127000E	27,99 €/u
12	3491227000E	27,99 €/u
13	3491327000E	27,99 €/u

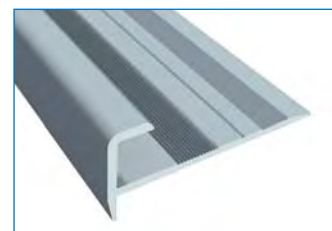

377

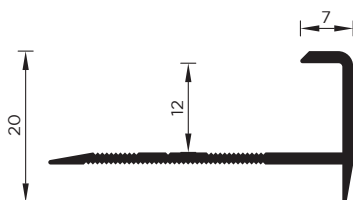

ALUM. 03	3770327000E	22,34 €/u
ALUM. 25	3772527000E	27,45 €/u



378

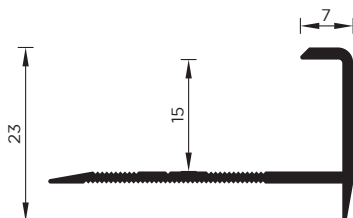

ALUM. 03	3780327000E	23,44 €/u
ALUM. 25	3782527000E	28,61 €/u

334

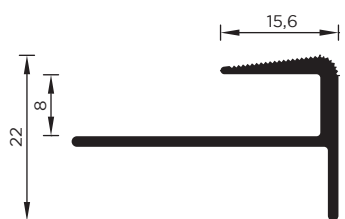

//// ALUM. 03 E ///	3340327000E	27,83 €/u
//// ALUM. 25 ///	3342527000E	33,19 €/u





**LOS BAJOPUERTAS DEFINITIVOS:
NO SE DESPEGAN NI DETERIORAN**

Cold, insects, dirt, humidity, noise. / Froid, insectes, saleté, humidité, bruit.

350

92 cm
Adhesivo
Adhesive
Adhésif

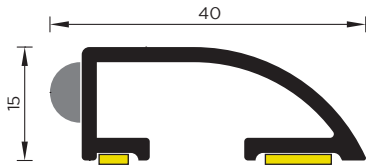

ALUM. 03	3500309230B	16,41 €/u
LAQ. - LB	350LB09230B	16,41 €/u
11	3501109230B	15,55 €/u
12	3501209230B	15,55 €/u
13	3501309230B	15,55 €/u



352

92 cm
Adhesivo
Adhesive
Adhésif

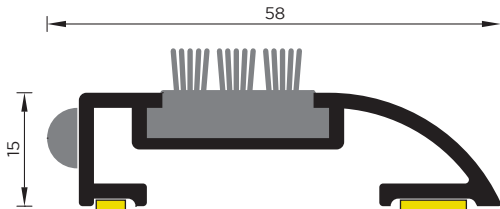

Cepillos / Brushes / Brosses

ALUM. 03	3520309231B	22,73 €/u
----------	-------------	-----------



356

92 cm
Adhesivo
Adhesive
Adhésif



Aluminio / Aluminium / Aluminium

ALUM. 03	3560309232B	11,66 €/u
ALUM. 05	3560509232B	11,66 €/u

**Plástico transparente adh. / Transparent plastic adh.
Plastique transparent adh. 100 cm**

V720000001	8,63 €/u
------------	----------



Aluminio - Aluminium - Aluminium

Ángulo de lados iguales - Equal sides angles - Angles côtés égaux

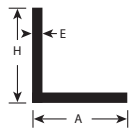

A (mm)	H (mm)	E (mm)	Long. - Leng. - Long.	Col. 03	Col. 25	Col. LB
10	10	1,6	300 cm	N170330000A 14,48 €/u	N172530000A 19,79 €/u	N17LB30000A 14,48 €/u
15	15	1,3	300 cm	N010330000A 10,97 €/u	N012530000A 16,13 €/u	N01LB30000A 10,97 €/u
20	20	1,3	300 cm	N020330000A 13,70 €/u	N022530000A 18,98 €/u	N02LB30000A 13,70 €/u
25	25	1,3	300 cm	N030330000A 15,53 €/u	-	-
30	30	1,3	300 cm	N040330000A 18,99 €/u	-	-
40	40	1,4	300 cm	N050330000A 26,43 €/u	-	-

Ángulo de lados desiguales - Unequal sides angles - Angles côtés inégaux

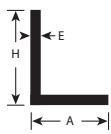

A (mm)	H (mm)	E (mm)	Long. - Leng. - Long.	Col. 03	Col. 25	Col. LB
25	15	1,3	300 cm	N060330000A 13,70 €/u	-	-
40	20	1,3	300 cm	N070330000A 18,99 €/u	-	-
60	30	1,4	300 cm	N080330000A 31,27 €/u	-	-
70	30	1,4	300 cm	N090330000A 32,23 €/u	-	-
20	5	1,3	300 cm	N160330000A 14,48 €/u	N162530000A 19,79 €/u	N16LB30000A 14,48 €/u

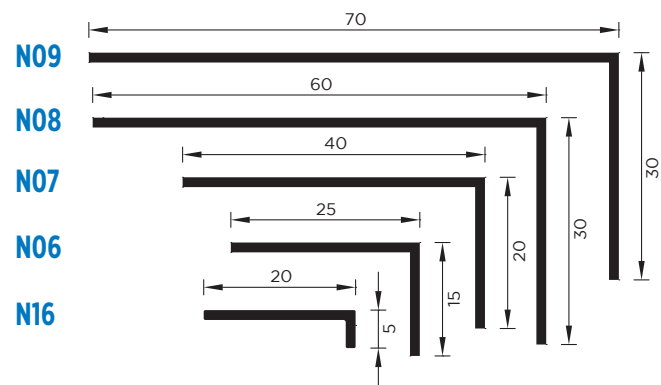
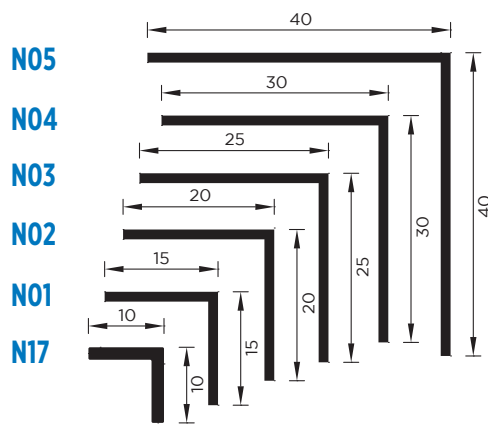

Tubo cuadrado - Square tube - Tube carré

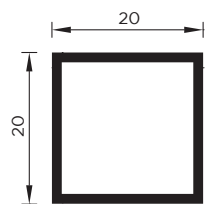

Long. - Leng. - Long.	Col. 03
300 cm	N100330000A 24,97 €/u

Perfil T - T Profile - Profil T

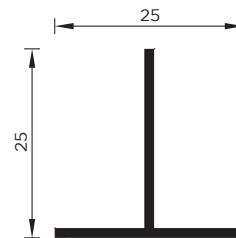

Long. - Leng. - Long.	Col. 03
300 cm	N120330000A 17,89 €/u

Consulte otras longitudes para grandes cantidades / Please consult other lengths for big orders / Consultez d'autres longueurs pour de grandes quantités

WOODLINE

Perfiles de aluminio recubiertos de madera natural

Real wood veneered aluminum profiles
Profils en aluminium avec placage bois véritable

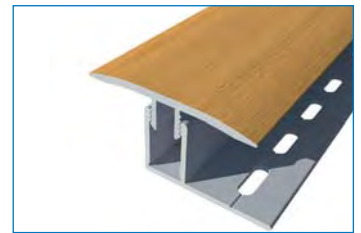

SISTEMA MULTIFIJACIÓN / MULTIFIX SYSTEM / SYSTÈME À CLIPSER

512 12-17 mm

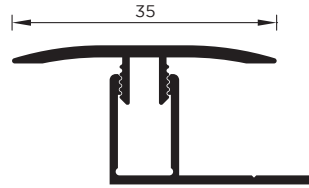
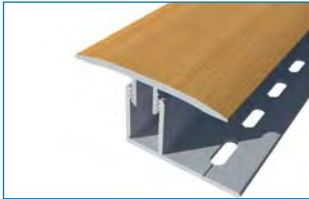

	90 cm	270 cm
50 Barniz-Varnish-Vernis	5125009013M	5125027013C
€/u	19,34	41,95
65	5126509013M	5126527013C
€/u	18,67	39,90

569 6-14 mm

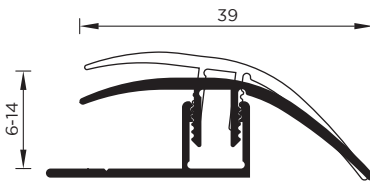

	90 cm	270 cm
50 Barniz-Varnish-Vernis	5695009013M	5695027013C
€/u	19,46	44,48
65	5696509013M	5696527013C
€/u	18,70	42,20

592 12-17 mm

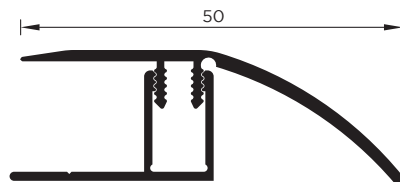

	90 cm	270 cm
50 Barniz-Varnish-Vernis	5925009013M	5925027013C
€/u	22,37	51,05
65	5926509013M	5926527013C
€/u	21,50	48,43

! Consulte la gama completa de bases. Pg. 20.
Please check the full range of bases. Pg. 20.
Veuillez consulter la gamme complète de bases. Pg. 20.

FIJACIÓN INVISIBLE / INVISIBLE FIXATION / FIXATION INVISIBLE

387 0-12 mm

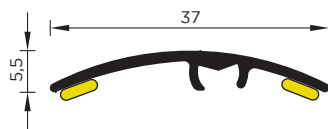

	93 cm	270 cm
50 Barniz-Varnish-Vernis	3875009301F	3875027001F
€/u	13,90	39,21
65	3876509301F	3876527001F
€/u	13,10	36,87

388 0-17 mm

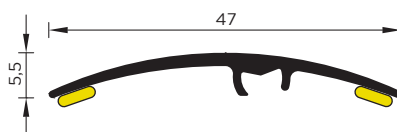

	93 cm	270 cm
50 Barniz-Varnish-Vernis	3885009301F	3885027001F
€/u	15,50	43,84
65	3886509301F	3886527001F
€/u	14,59	41,23



QUICK&PRO

370

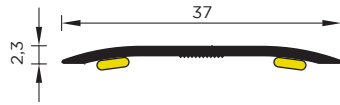

	90 cm	270 cm
50 Barniz-Varnish-Vernis	3705009001B	3705027001C
€/u	10,84	31,24
65	3706509001B	3706527001C
€/u	10,23	29,41

323-1 0-12 mm



2 en 1 / 2 in 1

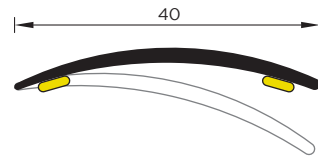

	90 cm	270 cm
50 Barniz-Varnish-Vernis	3235009001B	3235027001C
€/u	10,84	31,24
65	3236509001B	3236527001C
€/u	10,23	29,41

372 3-12 mm

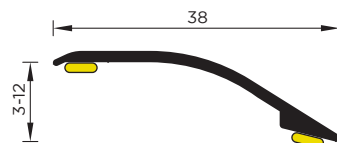

	90 cm	270 cm
50 Barniz-Varnish-Vernis	3725009001B	3725027001C
€/u	10,84	31,24
65	3726509001B	3726527001C
€/u	10,23	29,41

376 5-20 mm

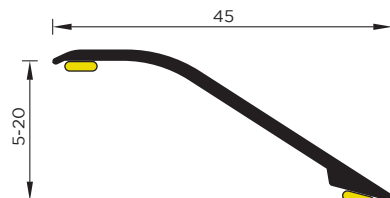

	90 cm	270 cm
50 Barniz-Varnish-Vernis	3765009001B	3765027001C
€/u	13,14	38,18
65	3766509001B	3766527001C
€/u	12,39	35,91

391 5-27 mm

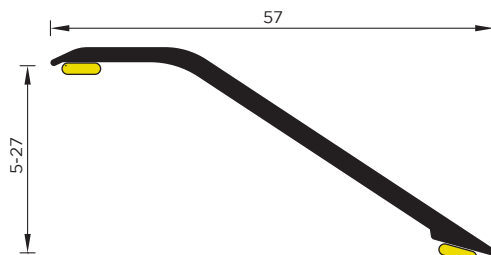
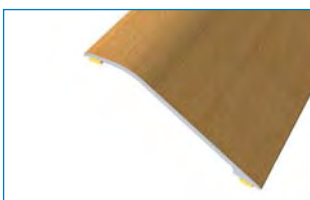

	90 cm	270 cm
50 Barniz-Varnish-Vernis	3915009001B	3915027001C
€/u	17,16	51,50
65	3916509001B	3916527001C
€/u	16,08	48,28

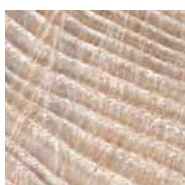

Perfiles recubiertos de madera natural
Real wood veneered profiles
Profils avec placage bois véritable

Woodline reúne las **ventajas** del aluminio con el aspecto vivo de la **madera natural**.
Woodline meets the **advantages** of the aluminium with the natural look of the **real wood**.
Woodline rassemble les **avantages** de l'aluminium avec l'aspect vivant du **bois véritable**.

50

Madera de roble barnizada mate.
Matt varnished oak real wood.
Bois de chêne vernis mat.

65

Madera de roble sin barnizar. Permite la aplicación de barnices, aceites, tintes, etc. para obtener un acabado a la carta.
Unvarnished oak wood. It lets the application of varnishes, oils, dyes, etc. to get a custom finish.
Bois de chêne brut. Il permet l'application de vernis, d'huiles, de teintures, etc. pour obtenir une finition à la carte.

Aluminio



Modelo 30. Cuadrado aluminio



Referencia

- C010325000P Aluminio plata mate M-302 cuadrado 9 mm 2,5 m
- C020825000P Aluminio plata brillo M-302 cuadrado 9 mm 2,5 m
- C03LB25000P Aluminio lacado blanco M-302 cuadrado 9 mm 2,5 m
- C040325000P Aluminio plata mate M-304 cuadrado 11 mm 2,5 m
- C050825000P Aluminio plata brillo M-304 cuadrado 11 mm 2,5 m
- C06LB25000P Aluminio lacado blanco M-304 cuadrado 11 mm 2,5 m

Precio

- 19,17 €/u
- 25,01 €/u
- 19,17 €/u
- 20,77 €/u
- 27,50 €/u
- 20,77 €/u

Modelo 32. Clásico aluminio



Referencia

- C080325000P Aluminio plata mate M-321 clásico 8 mm 2,5 m
- C090825000P Aluminio plata brillo M-321 clásico 8 mm 2,5 m
- C10LB25000P Aluminio lacado blanco M-321 clásico 8 mm 2,5 m
- C110325000P Aluminio plata mate M-322 clásico 10 mm 2,5 m
- C120825000P Aluminio plata brillo M-322 clásico 10 mm 2,5 m
- C13LB25000P Aluminio lacado blanco M-322 clásico 10 mm 2,5 m
- C140325000P Aluminio plata mate M-323 clásico 12 mm 2,5 m
- C150825000P Aluminio plata brillo M-323 clásico 12 mm 2,5 m
- C16LB25000P Aluminio lacado blanco M-323 clásico 12 mm 2,5 m

Precio

- 19,27 €/u
- 25,21 €/u
- 19,27 €/u
- 19,67 €/u
- 25,83 €/u
- 19,67 €/u
- 19,98 €/u
- 26,26 €/u
- 19,98 €/u

Modelo 34. Recto aluminio



Referencia

- C180325000P Aluminio plata mate M-342 recto 10 mm 2,5 m
- C190825000P Aluminio plata brillo M-342 recto 10 mm 2,5 m
- C20LB25000P Aluminio lacado blanco M-342 recto 10 mm 2,5 m
- C210325000P Aluminio plata mate M-343 recto 12 mm 2,5 m
- C220825000P Aluminio plata brillo M-343 recto 12 mm 2,5 m
- C23LB25000P Aluminio lacado blanco M-343 recto 12 mm 2,5 m

Precio

- 15,50 €/u
- 19,42 €/u
- 15,50 €/u
- 15,83 €/u
- 19,88 €/u
- 15,83 €/u

Modelo 40. Escalera aluminio

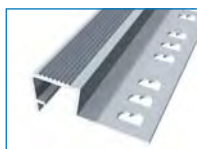

Referencia

- C250325000P Aluminio plata mate M-401 12 mm 2,5 m.

Precio

- 29,04 €/u

Aluminio con capa de protección de PVC.



BASIC LINE

PERFILES DE ACERO
STEEL PROFILES
PROFILS EN ACIER

Económicos - Resistentes - Extraplanos
Budget - Résistant - Slim
Économiques - Résistants - Extra-plats



acero - steel - acier

73/83 cm 15 u. 250 cm 10 u.

001

30 mm

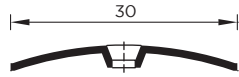

	73 cm	83 cm	250 cm
01	0010107312B	0010108312B	0010125012C
€/u	2,40	2,43	6,99
06	0010607312B	0010608312B	0010625012C
€/u	2,85	3,13	8,48
11	0011107312B	0011108312B	00111250012C
12	0011207312B	0011208312B	00112250012C
13	0011307312B	0011308312B	00113250012C
€/u	3,59	3,95	10,99

004

35 mm

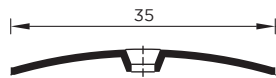

	83 cm	250 cm
01	0040108312B	0040125012C
€/u	3,05	8,85
06	0040608312B	0040625012C
€/u	3,93	10,90
11	0041108312B	0041125012C
12	0041208312B	0041225012C
13	0041308312B	0041325012C
€/u	4,34	13,19

040

40 mm

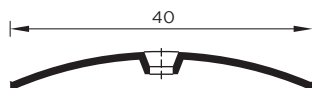

	83 cm	250 cm
01	0400108312B	0400125012C
€/u	3,36	9,81
06	0400608312B	0400625012C
€/u	4,60	12,06
11	0401108312B	0401125012C
12	0401208312B	0401225012C
13	0401308312B	0401325012C
€/u	4,64	13,61



73/83/93 cm
15 u.

250 cm
10 u.

acero - steel - acier

BASIC LINE



006
Adh.
30 mm

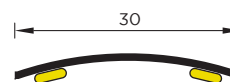

	73 cm	83 cm	250 cm
01	0060107301B	0060108301B	0060125001C
€/u	2,88	3,19	9,33
06	0060607301B	0060608301B	0060625001C
€/u	3,71	4,12	11,49
11	0061107301B	0061108301B	0061125001C
12	0061207301B	0061208301B	0061225001C
13	0061307301B	0061308301B	0061325001C
14	-	0061408301B	-
17	-	0061708301B	-
19	-	0061908301B	-
35	-	0063508301B	-
€/u	4,02	4,50	13,14

Cost-effective - Basic colours - Guarantee - Minimum volume
Resistant structure - Resistance to wear and tear and humidity - Perfect fixation

Économique - Couleurs basiques - Garantie - Volume minimale
Structure résistante - Résistance à l'usure et à l'humidité - Fixation parfaite

- Ahorro
- Volumen mínimo
- Colores básicos
- Estructura resistente
- Garantía
- Resistencia al desgaste
- Resistencia a la humedad
- Fijación perfecta

009
Adh.
35 mm



diy
166 cm

	73 cm	83 cm	250 cm
01	0090107301B	0090108301B	0090125001C
€/u	3,27	3,64	11,07
06	0090607301B	0090608301B	0090625001C
€/u	3,96	4,69	13,13
11	0091107301B	0091108301B	0091125001C
12	0091207301B	0091208301B	0091225001C
13	0091307301B	0091308301B	0091325001C
14	0091407301B	0091408301B	0091425001C
17	-	0091708301B	0091725001C
30	-	0093008301B	0093025001C
37	-	0093708301B	0093725001C
38	-	0093808301B	0093825001C
€/u	4,57	5,09	15,13

041
Adh.
40 mm

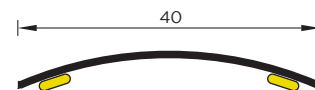

	83 cm	93 cm	250 cm
01	0410108301B	0410109301B	0410125001C
€/u	4,07	4,51	12,49
06	0410608301B	0410609301B	0410625001C
€/u	5,26	5,82	14,89
11	0411108301B	0411109301B	0411125001C
12	0411208301B	0411209301B	0411225001C
13	0411308301B	0411309301B	0411325001C
28	0412808301B	-	0412825001C
30	0413008301B	-	0413025001C
33	0413308301B	-	0413325001C
35	0413508301B	-	0413525001C
P1	041P108301B	-	041P125001C
P2	041P208301B	-	041P225001C
P3	041P308301B	-	041P325001C
€/u	5,34	5,91	15,77

acero - steel - acier

83/93 cm 15 u. 250 cm 10 u.

003

30 mm

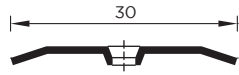

	83 cm	250 cm
01	0030108312B	0030125012C
€/u	2,45	7,30

035

35 mm

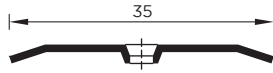

	83 cm	250 cm
01	0350108312B	0350125012C
€/u	3,25	9,12
06	0350608312B	0350625012C
€/u	4,20	10,85
11	0351108312B	0351125012C
12	0351208312B	0351225012C
13	0351308312B	0351325012C
€/u	4,54	12,77

005

40 mm



	83 cm	93 cm	250 cm
01	0050108312B	0050109312B	0050125012C
€/u	3,57	3,98	9,15
06	0050608312B	0050609312B	0050625012C
€/u	4,60	5,15	12,06
11	0051108312B	0051109312B	0051125012C
12	0051208312B	0051209312B	0051225012C
13	0051308312B	0051309312B	0051325012C
17	0051708312B	-	0051725012C
19	0051908312B	-	0051925012C
20	0052008312B	-	0052025012C
€/u	4,83	5,41	13,68

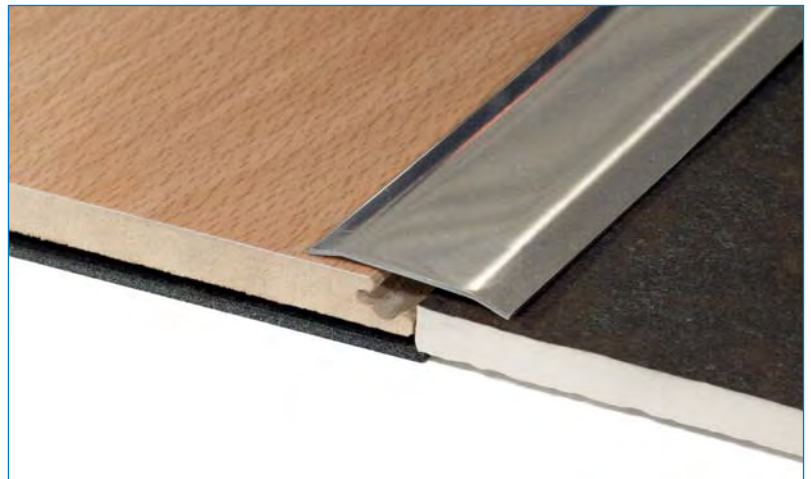

73/83/93 cm

250 cm

15 u.

10 u.

acero - steel - acier

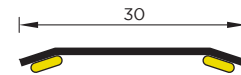

008

Adh.
30 mm

	83 cm	250 cm
01	0080108301B	0080125001C
€/u	3,17	9,19
11	0081108301B	-
12	0081208301B	-
13	0081308301B	-
€/u	4,47	-



Ahorro



Volumen mínimo



Colores básicos



Estructura resistente



Garantía



Resistencia al desgaste



Resistencia a la humedad



Fijación perfecta

Cost-effective - Colour range - Guarantee - Minimum volume
Resistant structure - Resistance to wear and tear and humidity - Perfect fixation

Économique - Gamme de couleurs - Garantie - Volume minimale
Structure résistante - Résistance à l'usure et à l'humidité - Fixation parfaite

036

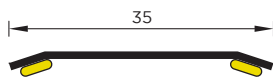
Adh.
35 mmdiy
166 cm

	73 cm	83 cm	250 cm
01	0360107301B	0360108301B	0360125001C
€/u	3,27	3,63	11,81
06	0360607301B	0360608301B	0360625001C
€/u	3,96	4,67	13,12
11	0361107301B	0361108301B	0361125001C
12	0361207301B	0361208301B	0361225001C
13	0361307301B	0361308301B	0361325001C
14	-	0361408301B	0361425001C
17	-	0361708301B	0361725001C
20	-	0362008301B	0362025001C
22	-	0362208301B	0362225001C
30	-	0363008301B	0363025001C
33	-	0363308301B	0363325001C
35	-	0363508301B	0363525001C
37	-	0363708301B	0363725001C
€/u	4,56	5,10	15,06

010

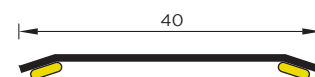
Adh.
40 mmdiy
166 cm

	83 cm	93 cm	250 cm
01	0100108301B	0100109301B	0100125001C
€/u	4,06	5,98	12,28
06	0100608301B	0100609301B	0100625001C
€/u	5,25	7,70	15,82
11	0101108301B	0101109301B	0101125001C
12	0101208301B	0101209301B	0101225001C
13	0101308301B	0101309301B	0101325001C
14	0101408301B	0101409301B	0101425001C
17	0101708301B	-	0101725001C
19	0101908301B	-	0101925001C
20	0102008301B	-	0102025001C
22	0102208301B	-	0102225001C
28	0102808301B	-	0102825001C
30	0103008301B	-	0103025001C
33	0103308301B	-	0103325001C
35	0103508301B	-	0103525001C
37	0103708301B	-	0103725001C
38	0103808301B	-	0103825001C
P1	010P108301B	-	010P125001C
P2	010P208301B	-	010P225001C
P3	010P308301B	-	010P325001C
€/u	5,34	7,76	16,09

acero - steel - acier

83/93 cm 15 u. 250 cm 10 u.



042
1-5 mm

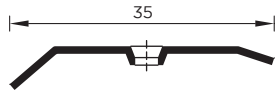

	83 cm	250 cm
o1	0420108312B	0420125012C
€/u	2,98	8,99

046
12-18 mm

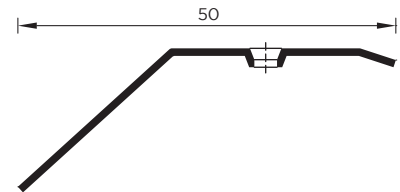

	83 cm	250 cm
o1	0460108312B	0460125012C
€/u	4,56	13,98
o6	0460608312B	0460625012C
€/u	5,89	16,83

044
5-12 mm

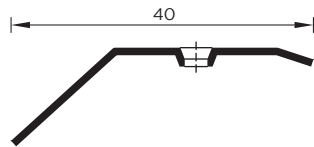

	93 cm	250 cm
o1	0440109312B	0440125012C
€/u	4,60	12,12

83 cm 250 cm
15 u. 10 u.

acero - steel - acier



043
Adh.
1-5 mm

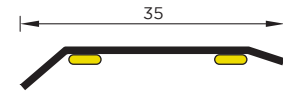

	83 cm	250 cm
o1	0430108301B	0430125001C
€/u	3,63	10,72
11	0431108301B	0431125001C
12	0431208301B	0431225001C
13	0431308301B	0431325001C
14	0431408301B	0431425001C
€/u	5,10	14,99

- Ahorro
- Volumen mínimo
- Colores básicos
- Estructura resistente
- Garantía
- Resistencia al desgaste
- Resistencia a la humedad
- Fijación perfecta

Cost-effective - Colour range - Guarantee - Minimum volume
Resistant structure - Resistance to wear and tear and humidity - Perfect fixation
Économique - Gamme de couleurs - Garantie - Volume minimale
Structure résistante - Résistance à l'usure et à l'humidité - Fixation parfaite

045
Adh.
5-12 mm

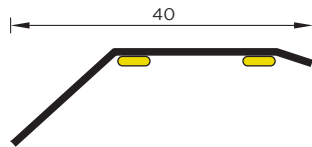

	83 cm	250 cm
o1	0450108301B	0450125001C
€/u	4,10	12,27
o6	0450608301B	0450625001C
€/u	5,30	14,95
11	0451108301B	0451125001C
12	0451208301B	0451225001C
13	0451308301B	0451325001C
14	0451408301B	0451425001C
17	0451708301B	0451725001C
19	0451908301B	0451925001C
30	0453008301B	0453025001C
35	0453508301B	0453525001C
P1	045P108301B	045P125001C
P2	045P208301B	045P225001C
P3	045P308301B	045P325001C
€/u	5,34	15,84

047
Adh.
12-18 mm

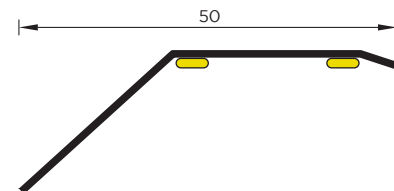

	83 cm	250 cm
o1	0470108301B	0470125001C
€/u	5,33	15,80
o6	0470608301B	0470625001C
€/u	6,88	19,00
11	0471108301B	0471125001C
12	0471208301B	0471225001C
13	0471308301B	0471325001C
14	0471408301B	0471425001C
19	0471908301B	0471925001C
20	0472008301B	0472025001C
22	0472208301B	0472225001C
€/u	5,98	18,03

acero - steel - acier

013



8-14 mm

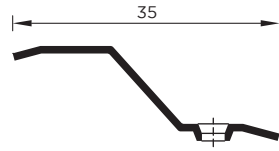

	73 cm	83 cm	93 cm	250 cm
01	0130107312B	0130108312B	0130109312B	0130125012C
€/u	3,25	3,36	3,98	10,07
06	0130607312B	0130608312B	0130609312B	0130625012C
€/u	3,63	4,34	5,15	12,06
11	0131107312B	0131108312B	0131109312B	0131125012C
12	0131207312B	0131208312B	0131209312B	0131225012C
13	0131307312B	0131308312B	0131309312B	0131325012C
14	-	0131408312B	0131409312B	0131425012C
€/u	4,37	4,64	5,42	14,85



73/83/93 cm 250 cm
15 u. 10 u.



014
Adh.
8-14 mm

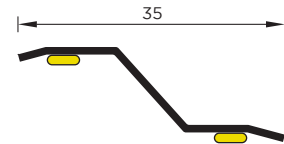

	73 cm	83 cm	93 cm	250 cm
01	0140107301B	0140108301B	0140109301B	0140125001C
€/u	3,68	4,07	4,56	12,29
06	0140607301B	0140608301B	0140609301B	0140625001C
€/u	4,47	5,26	5,89	15,21
11	0141107301B	0141108301B	0141109301B	0141125001C
12	0141207301B	0141208301B	0141209301B	0141225001C
13	0141307301B	0141308301B	0141309301B	0141325001C
14	0141407301B	0141408301B	0141409301B	0141425001C
17	0141707301B	0141708301B	0141709301B	0141725001C
20	-	0142008301B	-	-
22	-	0142208301B	-	-
28	-	0142808301B	-	-
30	-	0143008301B	-	-
31	-	0143108301B	-	-
33	-	0143308301B	-	-
35	-	0143508301B	-	-
37	-	0143708301B	-	-
38	-	0143808301B	-	-
P1	-	014P108301B	-	-
P2	-	014P208301B	-	-
P3	-	014P308301B	-	-
€/u	4,82	5,40	5,95	16,24

250 cm
10 u.

A Granel Bulk Vrac

acero - steel - acier



BASIC LINE

052 Adh.

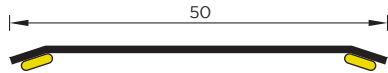

060 Adh.

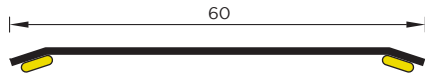

080 Adh.

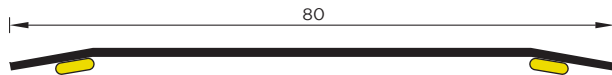

100 Adh.

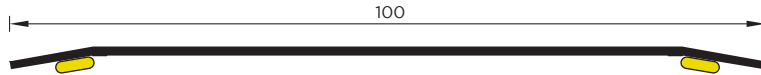

120 Adh.

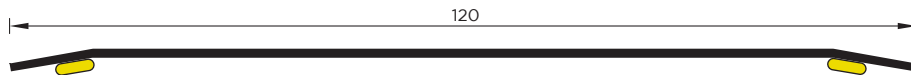

	Ref. 052 50 mm Adh. 250 cm	Ref. 060 60 mm Adh. 250 cm	Ref. 080 80 mm Adh. 250 cm	Ref. 100 100 mm Adh. 250 cm	Ref. 120 120 mm Adh. 250 cm
23	0522325001A	0602325001A	0802325001A	1002325001A	1202325001A
€/u	19,30	21,86	24,50	28,46	35,22
12	0521225001A	-	0802125001A	-	1201225001A
13	0521325001A	-	0801325001A	-	1201325001A
€/u	18,21	-	25,84	-	38,57



Perfiles de acero inoxidable de 1 mm / 1 mm stainless steel profiles / Profils en acier inoxydable de 1 mm



050



0502325012A 17,18 €/u

060

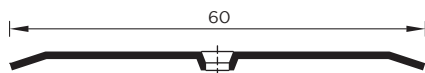

0602325012A 20,96 €/u

080

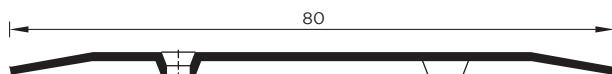

0802325010A 25,13 €/u

100



1002325010A 30,90 €/u

120



1202325010A 35,25 €/u

034

Adh.

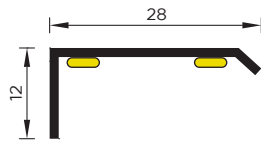

01	0340125001C	11,95 €/u
11	0341125001C	15,77 €/u
12	0341225001C	15,77 €/u
13	0341325001C	15,77 €/u



28x12 mm

016

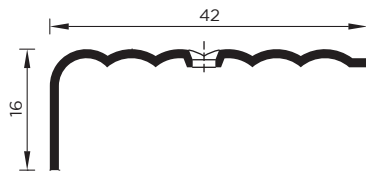

01	0160125012C	9,46 €/u
----	-------------	----------



42x16 mm

016

Adh.

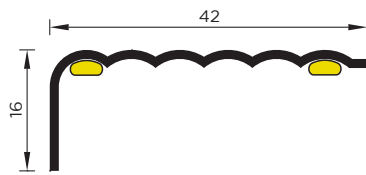

01	0160125001C	11,82 €/u
----	-------------	-----------



42x16 mm

062

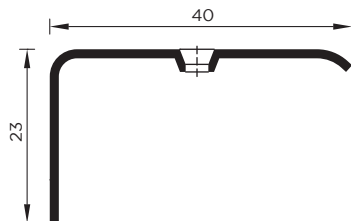

23	0622325012C	18,50 €/u
13	0621325012C	20,86 €/u



40x25 mm

062

Adh.

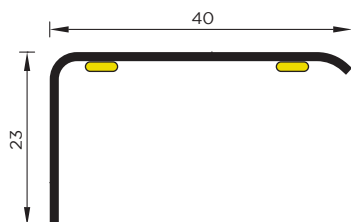

23	0622325001C	22,50 €/u
13	0621325001C	21,57 €/u



40x25 mm

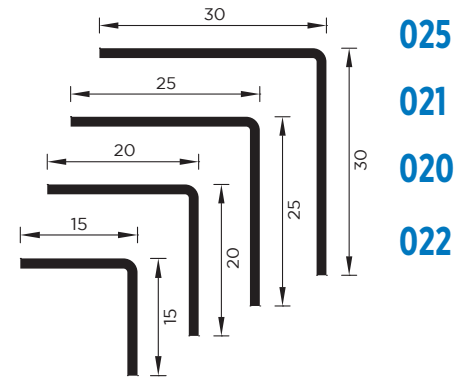
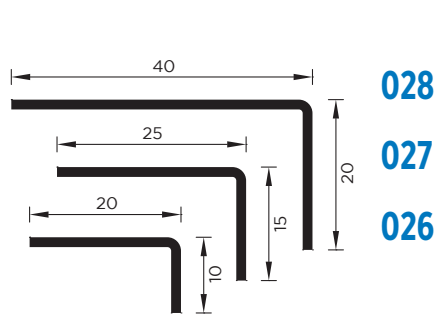

20x10 mm

25x15 mm

40x20 mm

15x15 mm

20x20 mm

25x25 mm

30x30 mm

01	0260125000C	0270125000C	0280125000C	0220125000C	0200125000C	0210125000C	0250125000C
€/u	7,23	10,06	16,07	5,14	7,95	13,75	16,07
11	0261125000C	0271125000C	-	0221125000C	0201125000C	0211125000C	-
12	0261225000C	0271225000C	-	0221225000C	0201225000C	0211225000C	-
13	0261325000C	0271325000C	0281325000C	0221325000C	0201325000C	0211325000C	0251325000C
20	0262025000C	0272025000C	-	0222025000C	0202025000C	0212025000C	-
22	0262225000C	0272225000C	-	0222225000C	0202225000C	0212225000C	-
€/u	10,99	13,61	18,03	11,01	13,77	15,54	19,30



Acero

Ángulo

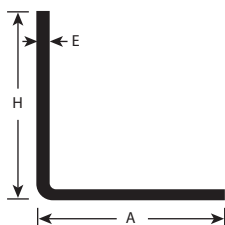

A (mm)	H (mm)	E (mm)	Acabado	300 cm	
10	10	1	BA+PVC	P020PB300000	10,12 €/u
15	15	1	BA+PVC	P001PB300000	13,11 €/u
20	20	1	BA+PVC	P003PB300000	16,14 €/u
25	25	1,5	BA+PVC	P004PB300000	25,89 €/u
30	30	1	BA+PVC	P005PB300000	22,13 €/u
30	30	1,5	BA+PVC	P006PB300000	30,38 €/u
20	10	1	BA+PVC	P002PB300000	13,11 €/u

Perfil U

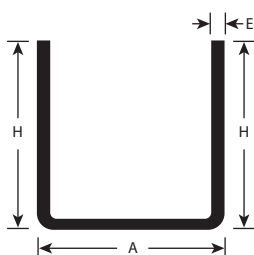

A (mm)	H (mm)	E (mm)	Acabado	300 cm	
10	15	1	BA+PVC	P021PB300000	15,82 €/u
12	15	1	BA+PVC	P022PB300000	16,42 €/u
15	15	1	BA+PVC	P023PB300000	17,34 €/u
12	25	1	BA+PVC	P025PB300000	22,40 €/u
15	30	1	BA+PVC	P024PB300000	26,33 €/u

Para pedidos superiores a 300 m. l. consulte precios.

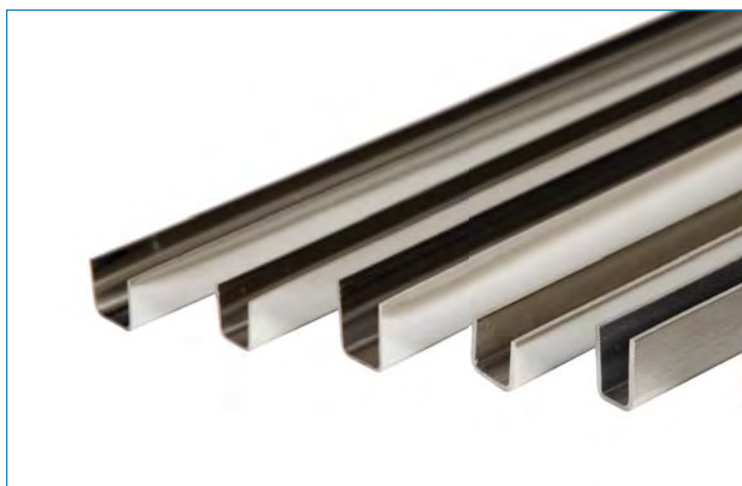



**LA BARRERA
ANTISUCIEDAD**

**LE TAPIS D'ENTRÉE
SYSTÈME CLIC**

**THE CLICK
ENTRANCE MATTING**





DIM. (cm)	REF.	COL.	DESCRIPCIÓN / DESCRIPTION / DESCRIPTION
60x80 cm	K2001	Negro / Black / Noir	Felpudo de poliamida Basmat
	K2002	Gris / Grey / Gris	Basmat polyamide doormat
	K2003	Burdeos / Bordeaux / Bordeaux	Tapis d'entrée en polyamide Basmat
60x180 cm	K2004	Negro / Black / Noir	Felpudo de poliamida Basmat
	K2005	Gris / Grey / Gris	Basmat polyamide doormat
	K2006	Burdeos / Bordeaux / Bordeaux	Tapis d'entrée en polyamide Basmat
80x120 cm	K2007	Negro / Black / Noir	Felpudo de poliamida Basmat
	K2008	Gris / Grey / Gris	Basmat polyamide doormat
	K2009	Burdeos / Bordeaux / Bordeaux	Tapis d'entrée en polyamide Basmat

Felpudo desinfectante / Disinfectant mat / Tapis désinfectant

①

Aplique solución germicida en la zona de desinfección
 Apply disinfectant solution on the disinfection area
 Appliquez une solution germicide sur la zone de désinfection

②

El paso por la zona de secado completa el proceso de limpieza
 Passing through the drying area completes the cleaning process
 Le passage sur la zone de séchage complète le processus de nettoyage

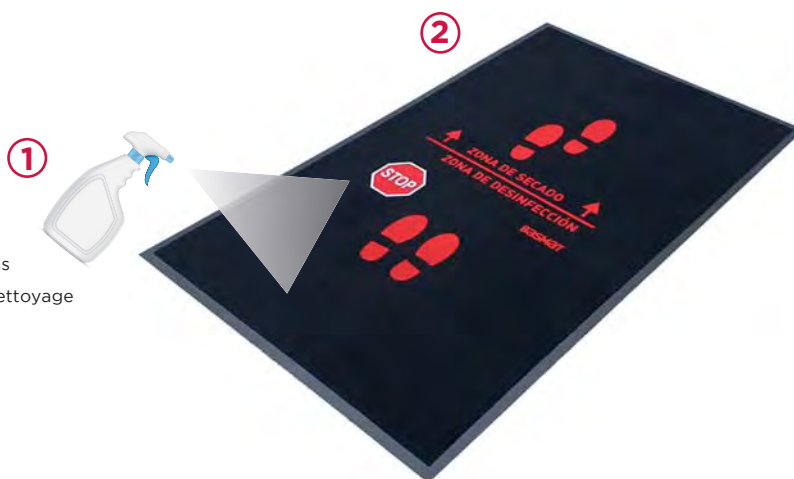

DIM. (cm)	REF.	DESCRIPCIÓN / DESCRIPTION / DESCRIPTION
90x150 cm	K2010	Felpudo desinfectante con área de secado (texto en español)
	K2011	Disinfectant mat with drying area (text in English)
	K2013	Tapis d'entrée en polyamide Basmat (texte en français)
	K2012	Tapete desinfectante com área de secagem (texto em português)
-	K2022	Solución desinfectante pulverizador 1 litro
-	K2024	Solución desinfectante envase de 5 litros

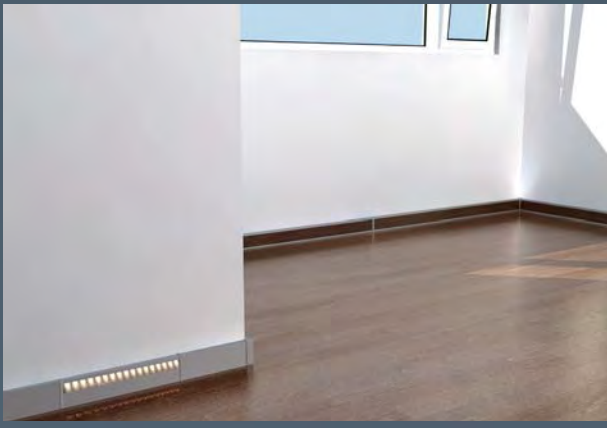

ZÓCALOS
SKIRTING
PLINTHES



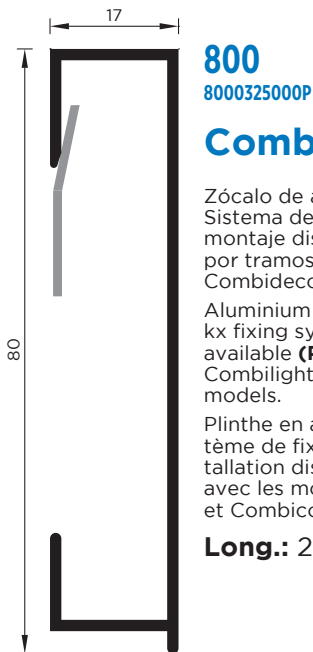

800
8000325000P

CombiAlu 80 mm

Zócalo de aluminio de líneas rectas. Sistema de anclaje Blickx. **Accesorios** de montaje disponibles (**Pg. 71**). Combinable por tramos con los modelos Combilight, Combideco y Combicover.

Aluminium skirting with straight lines. Blickx fixing system. Installation **accessories** available (**Pg. 71**). It can be combined with Combilight, Combideco and Combicover models.

Plinthe en aluminium de lignes droites. Système de fixation Blickx. **Accessoires** d'installation disponibles (**Pg. 71**). Combinable avec les modèles Combilight, Combideco et Combicover.

Long.: 250 cm.

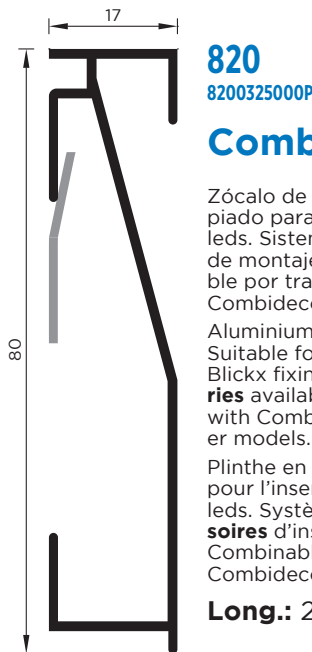

820
8200325000P

CombiLight 80 mm

Zócalo de aluminio de líneas rectas. Apropiado para inserción de tira luminosa de leds. Sistema de anclaje Blickx. **Accesorios** de montaje disponibles (**Pg. 71**). Combinable por tramos con los modelos Combialu, Combideco y Combicover.

Aluminium skirting with straight lines. Suitable for the insertion of a light led strip. Blickx fixing system. Installation **accessories** available (**Pg. 71**). It can be combined with Combialu, Combideco and Combicover models.

Plinthe en aluminium droite. Appropriée pour l'insertion d'une bande lumineuse à leds. Système de fixation Blickx. **Accessoires** d'installation disponibles (**Pg. 71**). Combinable avec les modèles Combialu, Combideco et Combicover.

Long.: 250 cm.

32,87 €/u.

32,87 €/u.

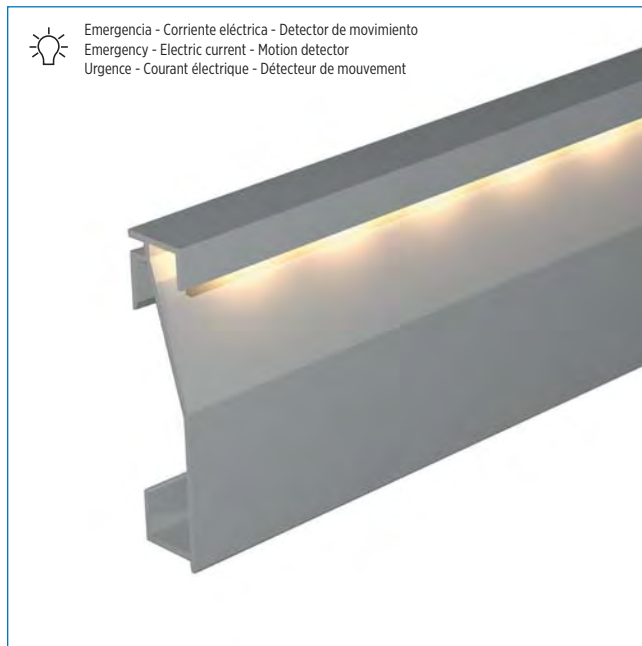

 Emergencia - Corriente eléctrica - Detector de movimiento
 Emergency - Electric current - Motion detector
 Urgence - Courant électrique - Détecteur de mouvement

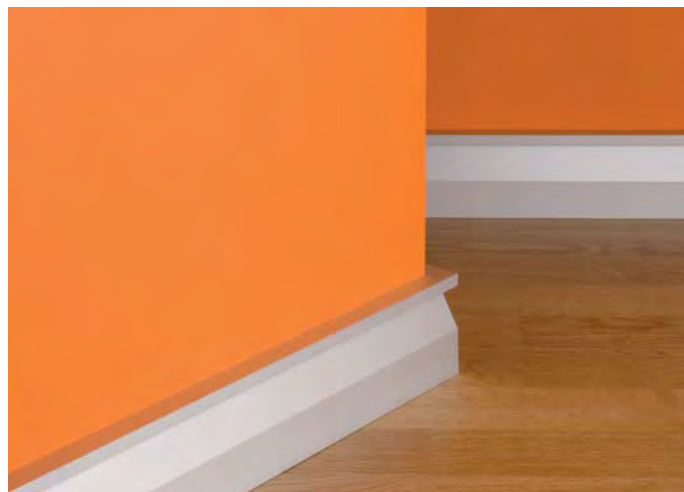
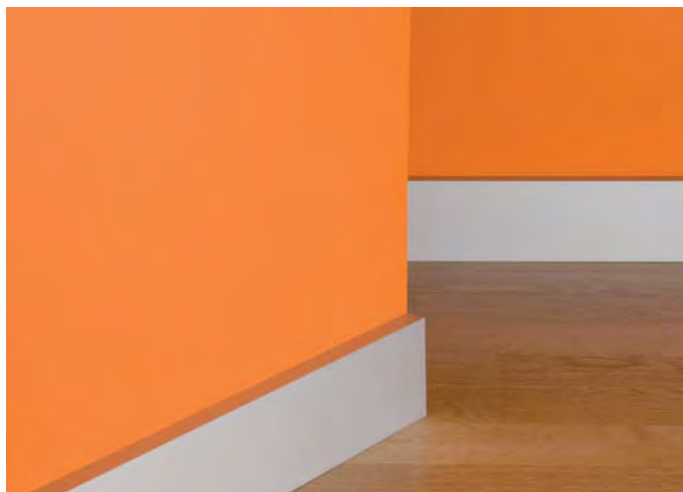

Film de protección de PVC / PVC protection sheet / Couche de protection PVC

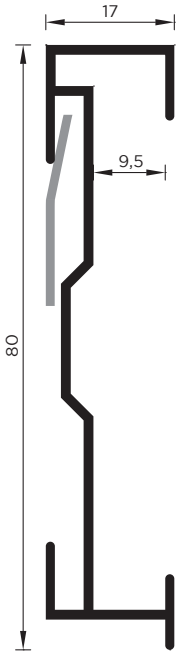

830
8300325000P

CombiDeco 80 mm

Zócalo de aluminio de líneas rectas. Apropiado para la inserción de piezas de suelo laminado. Sistema de anclaje Blickx. **Accesorios** de montaje disponibles (**Pg. 71**). Combinable por tramos con los modelos Combialu, Combilight y Combicover.

Aluminium skirting with straight lines. Suitable for the insertion of laminated floor pieces. Blickx fixing system. Installation **accessories** available (**Pg. 71**). It can be combined with Combialu, Combilight and Combicover models.

Plinthe en aluminium de lignes droites. Appropriée pour l'insertion de pièces de sol stratifié. Système de fixation Blickx. **Accessoires** d'installation disponibles (**Pg. 71**). Combinable avec les modèles Combialu, Combilight et Combicover.

Long.: 250 cm.

32,87 €/u.

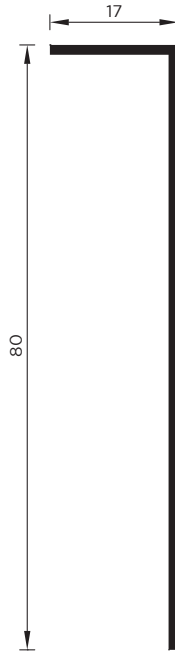

840
8400325000P

CombiCover 80 mm

Cubrezócalo de aluminio de líneas rectas. **Accesorios** de montaje disponibles (**Pg. 71**). Combinable por tramos con los modelos Combialu, Combilight y Combideco.

Aluminium skirting cover with straight lines. Installation **accessories** available (**Pg. 71**). It can be combined with Combialu, Combilight and Combicover models.

Couvre-plinthe en aluminium de lignes droites. **Accessoires** d'installation disponibles (**Pg. 71**). Combinable avec les modèles Combialu, Combilight et Combideco.

Long.: 250 cm.

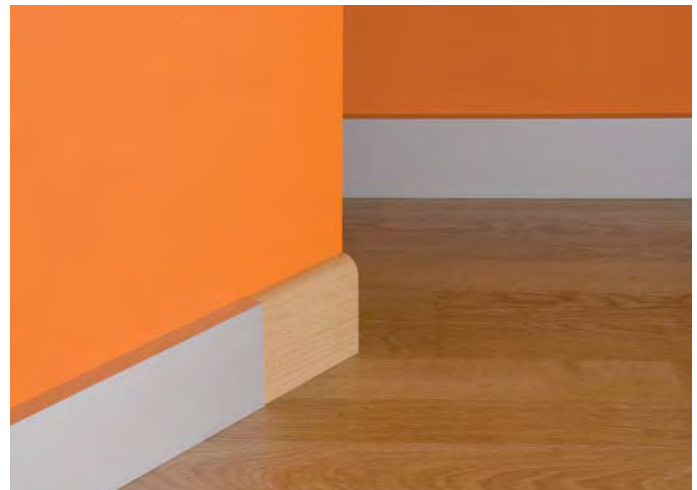
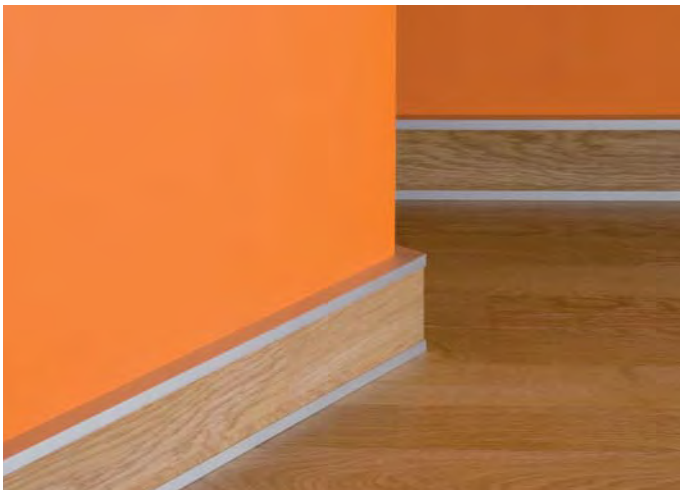

22,87 €/u.



SKIRTING - PLINTHES

aluminio - aluminium - aluminium

6 Series



 Solicite precio para cantidades
 Ask quotation linked to quantities
 Consultez les prix liés aux quantités



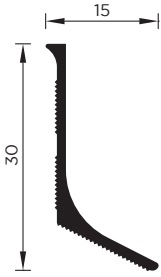

734
7340325000P

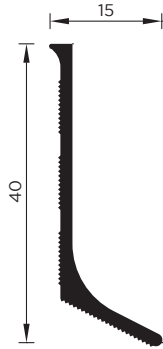

11,58 €/u.

735*
7350325000P



15,15 €/u.

730*
7300325000P

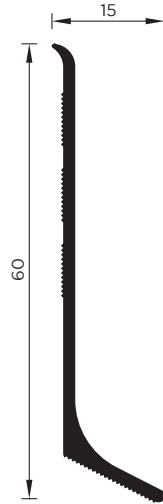

19,32 €/u.

737
7370325000P

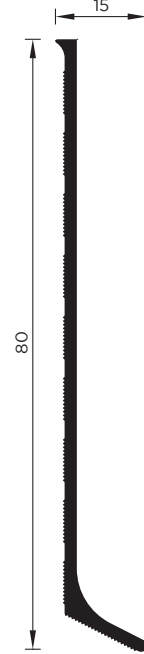

30,56 €/u.

736*
7360325000P

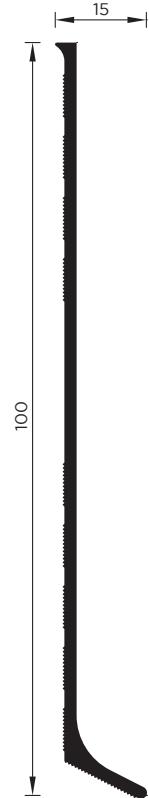

35,83 €/u.

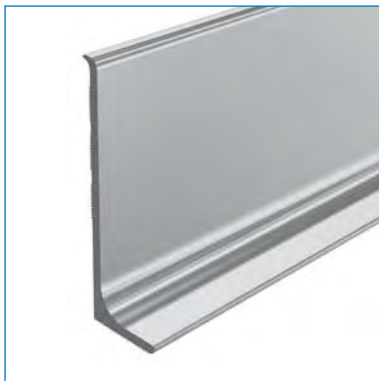

Zócalo de aluminio de líneas curvas. Acabado lacado blanco disponible según cantidad. (*) **Accesorios** de montaje disponibles (Pg. 71).

Aluminium skirting with curved lines. (*) Installation **accessories** available (Pg. 71).

Plinthe en aluminium de lignes courbes. (*) **Accessoires** d'installation disponibles (Pg. 71).

Long.: 250 cm.

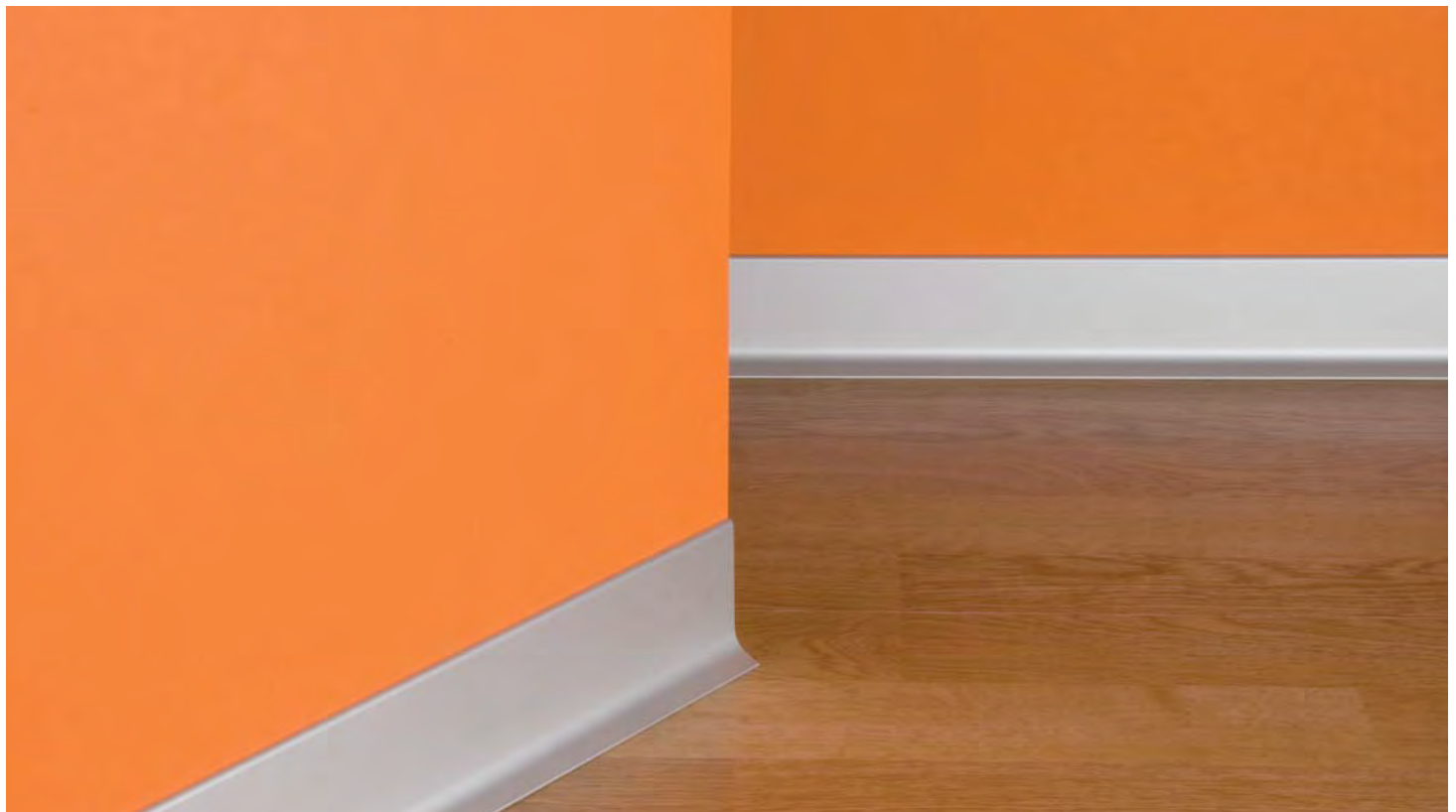

Film de protección de PVC / PVC protection sheet / Couche de protection PVC

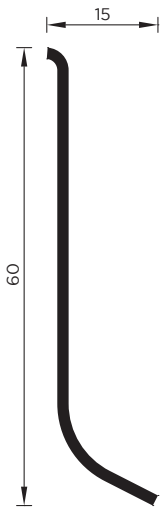

124
1240125000A

inox

6 Series

Zócalo de acero inoxidable de líneas curvas.
Stainless steel skirting with curved lines.
Plinthe en acier inoxydable de lignes courbes.

Long.: 250 cm.

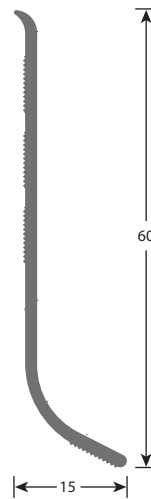

904
904**25000A

plastic

6 Series

Zócalo de plástico de líneas curvas. **Accesorios** de montaje disponibles (**Pg. 71**).
Colores: aluminio (R1), cerezo (R2), arce (R3), sapeli (R5), haya (R6), blanco (R7), negro (R8) y roble (R9).

Plastic skirting with curved lines. Installation **accessories** available (**Pg. 71**).
Colours: aluminium (R1), cherry (R2), maple (R3), sapelli (R5), beech (R6), white (R7), black (R8) and oak (R9).

Plinthe en plastique de lignes courbes. **Accessoires** d'installation disponibles (**Pg. 71**).
Couleurs: aluminium (R1), cerisier (R2), érable (R3), sapelli (R5), hêtre (R6), blanc (R7), noir (R8) et chêne (R9).

Long.: 250 cm.

13,42 €/u.

9,08 €/u.

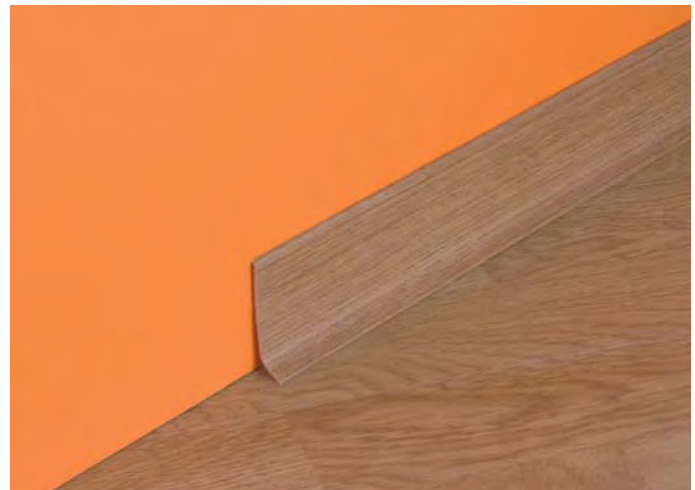
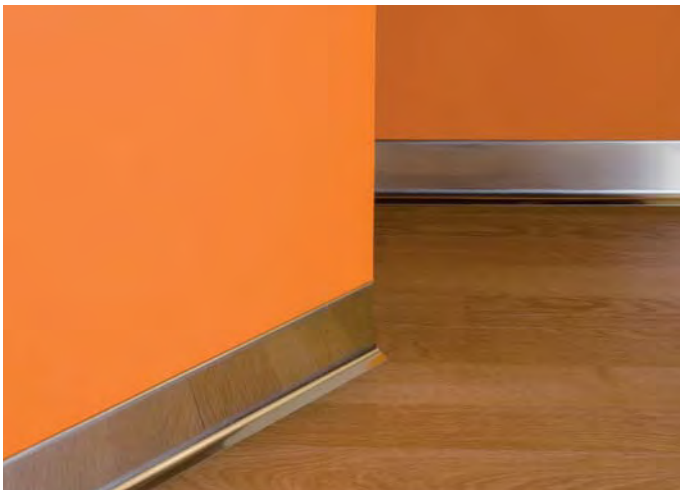
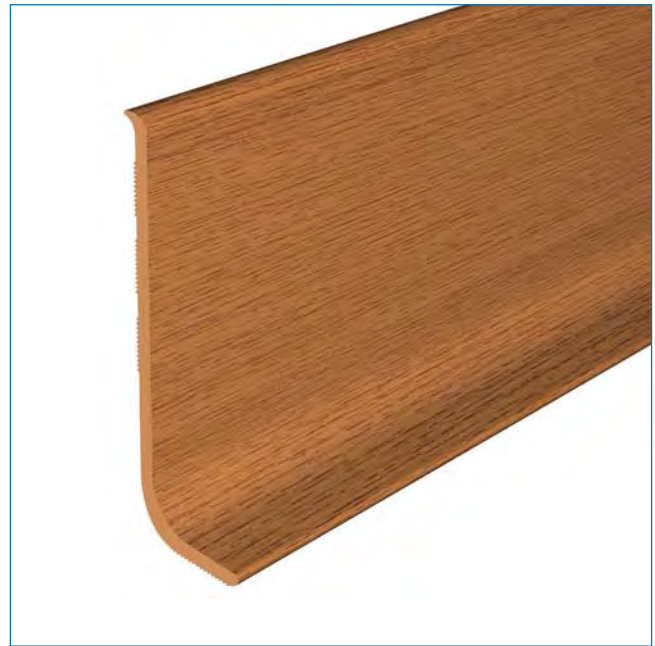
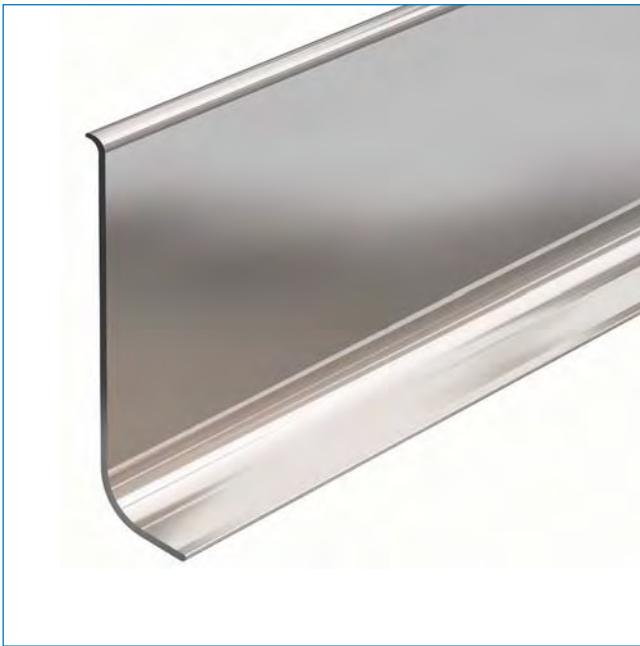

Office Series

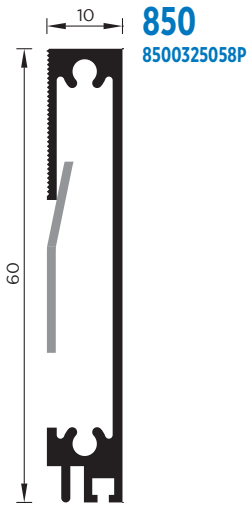

850
8500325058P

27,61 €/u.

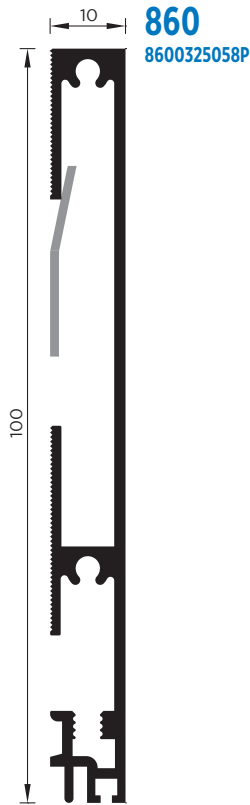

860
8600325058P

39,63 €/u.

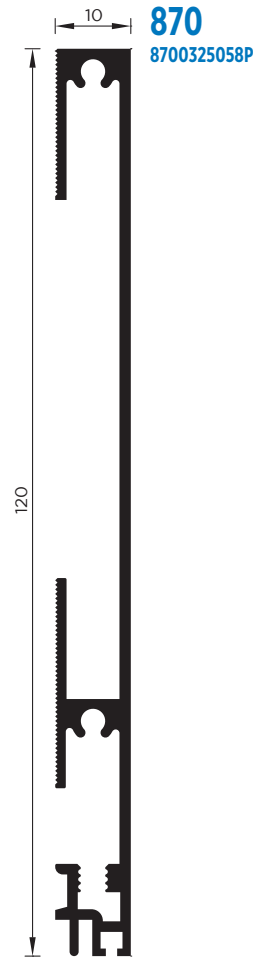

870
8700325058P

48,31 €/u.

Zócalo de aluminio de líneas rectas. Sistema de anclaje Blickx. **Accesorios** de montaje de aluminio disponibles (**Pg. 71**).

Aluminium skirting with straight lines. Blickx fixing system. Installation aluminium **accessories** available (**Pg. 71**).

Plinthe en aluminium de lignes droites. Système de fixation Blickx. **Accessoires** d'installation en aluminium disponibles (**Pg. 71**).

Long.: 250 cm.

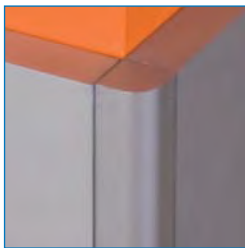

Accesorios de montaje de aluminio
 Aluminium installation accessories
 Accessoires pour l'installation en aluminium
Pg. 71

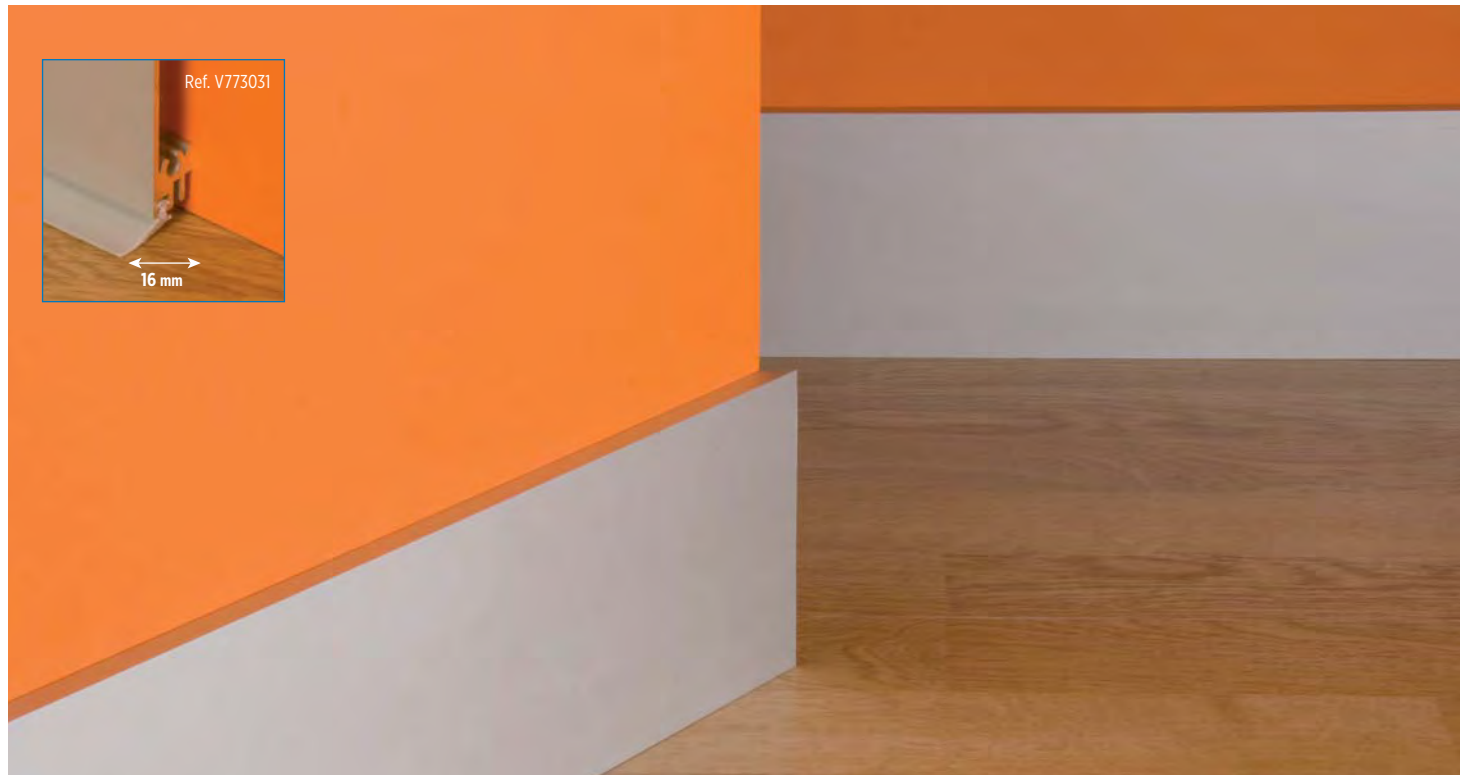

5 **121**
1212625000A

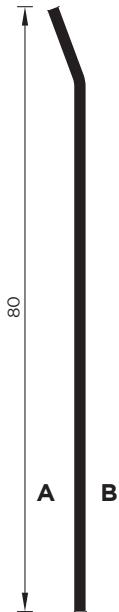

19,80 €/u.

5 **122**
1222625000A

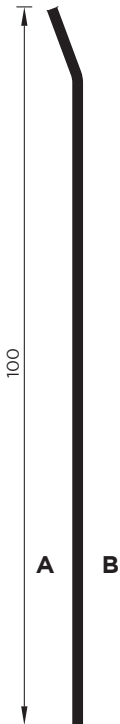

Inox Series

Zócalo de acero inoxidable reversible.
Reversible stainless steel skirting.
Plinthe réversible en acier inoxydable.
Long.: 250 cm.

25,21 €/u.

inox

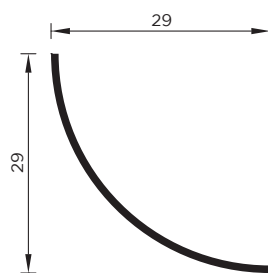
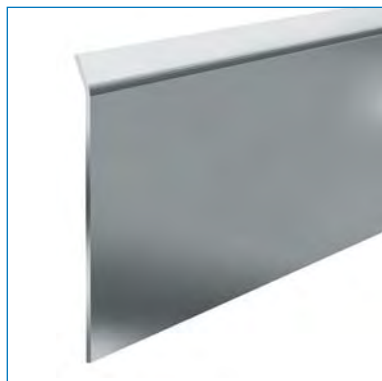

049
0490125000C
Blister

Inox Series

Rinconera de acero inoxidable.
Stainless steel round corner.
Cornière en acier inoxydable.
Long.: 250 cm.

9,76 €/u.

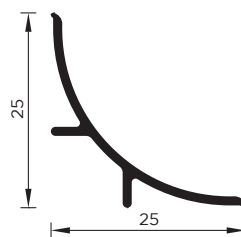
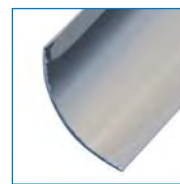

373
3730327000C
Blister

Alu



Rinconera de aluminio.
Aluminium round corner.
Cornière en aluminium.
Long.: 270 cm.

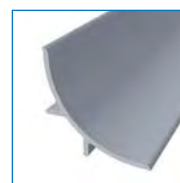

19,65 €/u.



SKIRTING - PLINTHES

aluminio - aluminium - aluminium



 Solicite precio para cantidades
 Ask quotation linked to quantities
 Consultez les prix liés aux quantités

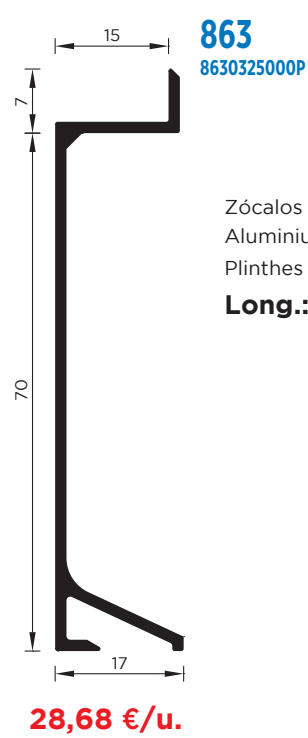
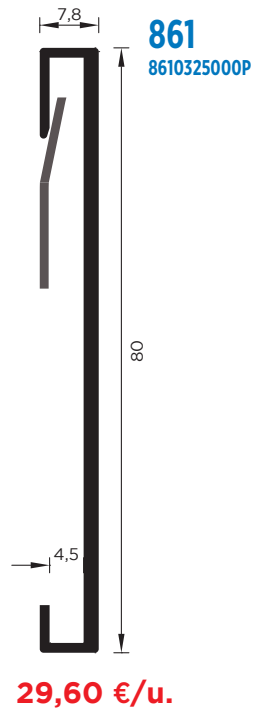
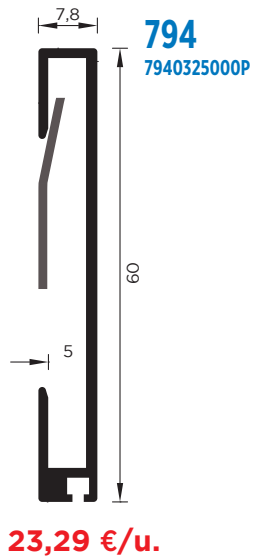

Zócalos de aluminio de líneas rectas.
 Aluminium skirting with straight lines.
 Plinthes en aluminium droite.
Long.: 250 cm.

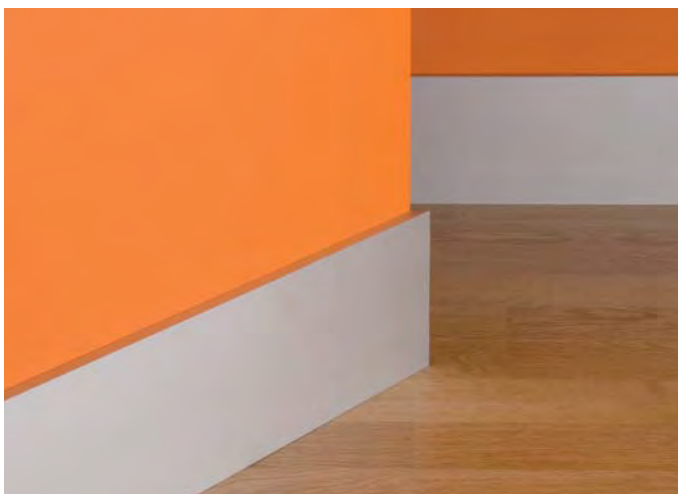
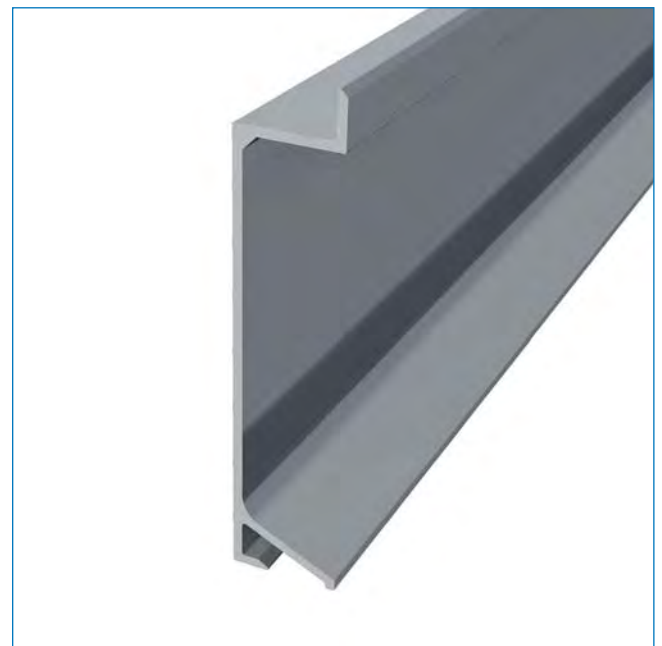
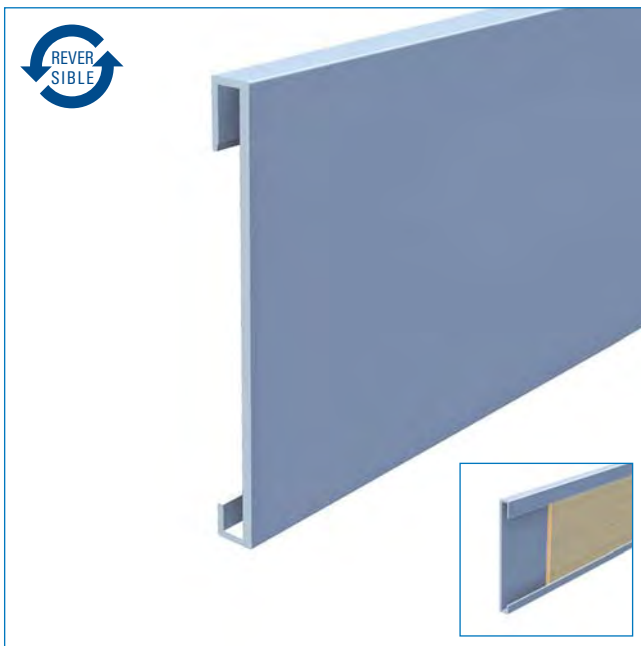

Film de protección de PVC / PVC protection sheet / Couche de protection PVC

225 cm
19u.

A Granel Bulk Vrac

225 cm
15u.

A Granel Bulk Vrac

% % % Solicite precio para cantidades
Ask quotation linked to quantities
Consultez les prix liés aux quantités

SKIRTING - PLINTHES
plástico - plastic - plastique

ZÓCALOS

Albion Series

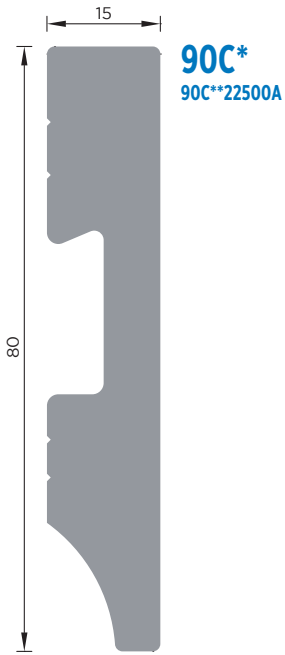

90C*
90C**22500A

13,40 €/u.

(*) Colores / Colours / Couleurs
W1 - D7 - S9 - 42 - 84 - F6

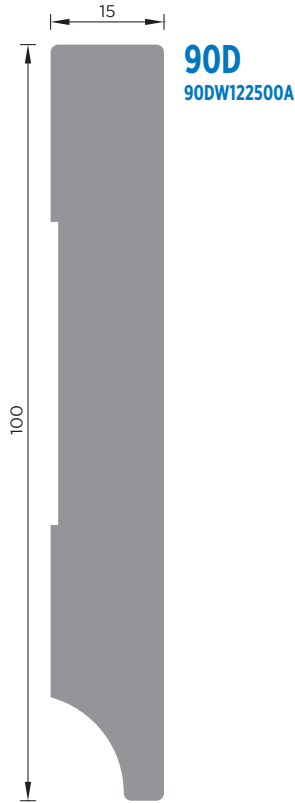

90D
90DW122500A

17,32 €/u.

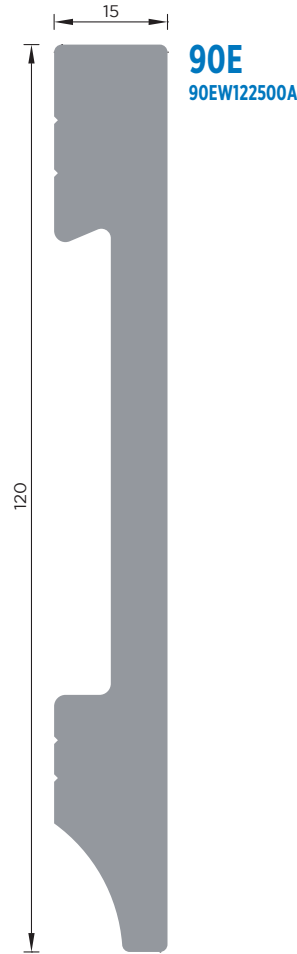

90E
90EW122500A

20,41 €/u.

waterproof

Zócalo de poliestireno de líneas rectas.
Color blanco satinado (W1). Resistente a la humedad.

Polystyrene skirting with straight lines.
Satin white colour (W1). Waterproof.

Plinthe en polystyrène de lignes droites.
Couleur blanc satiné (W1). Utilisable dans les zones humides.

Long.: 225 cm.

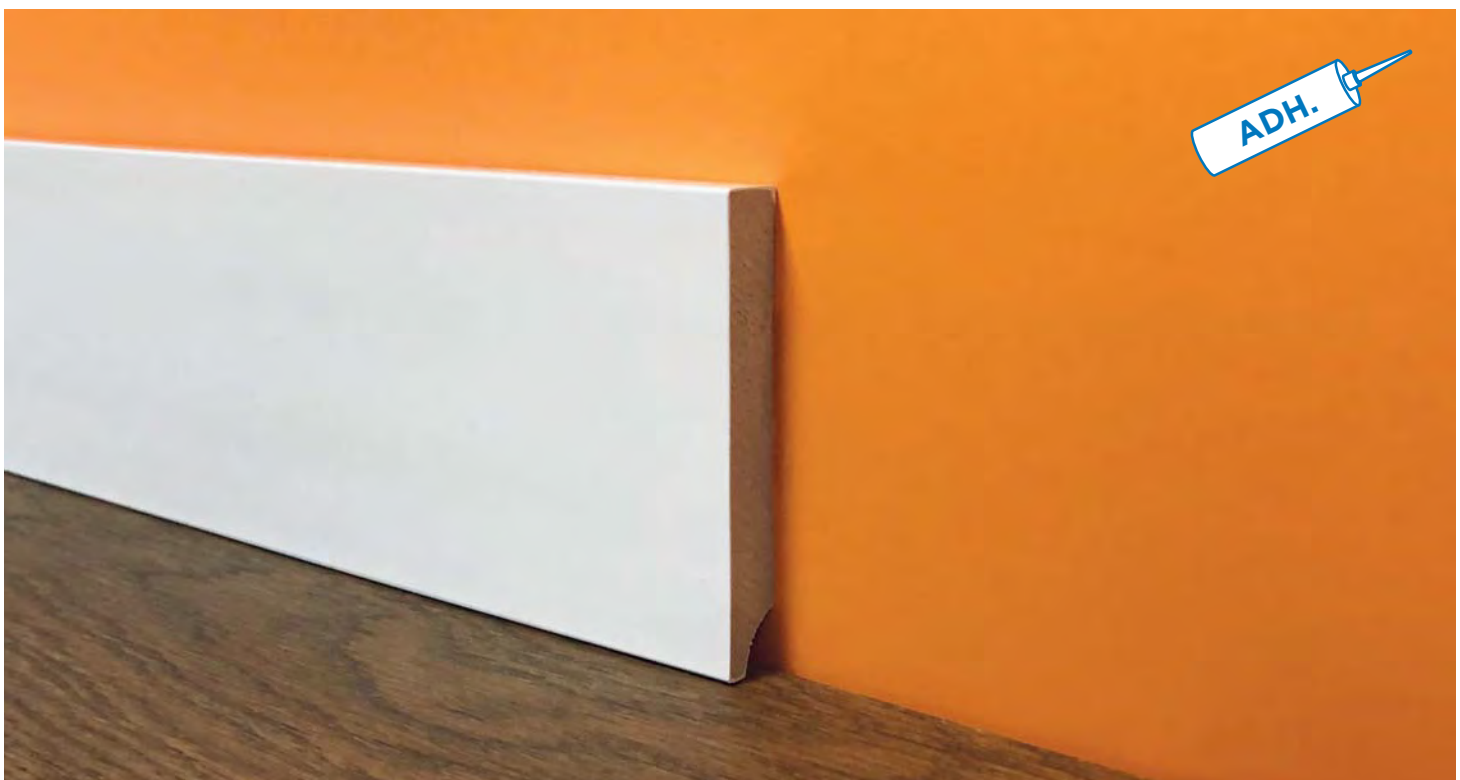

SKIRTING - PLINTHES

plástico - plastic - plastique

% Solicite precio para cantidades
Ask quotation linked to quantities
% Consultez les prix liés aux quantités

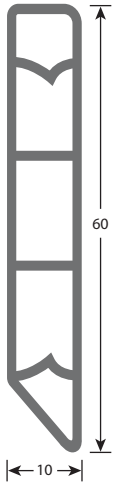
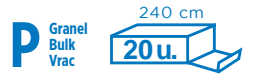

908
908**24000P

Zócalo de plástico de líneas rectas. Acabados: blanco y roble. Consulte pedidos mínimos.

Plastic skirting with straight lines. Finishes: white and oak. Please consult minimum orders.

Plinthe en plastique de lignes droites. Finitions: blanc et chêne. Merci de nous consulter pour les quantités minimum.

Long.: 240 cm.

18,12 €/u.

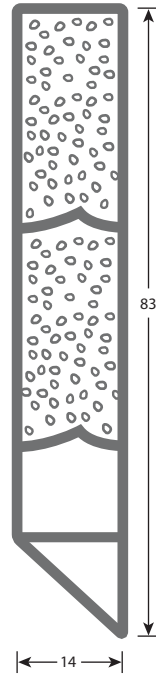

909
909**24000P

Zócalo de plástico + espuma de líneas rectas. Acabados: blanco, roble, sapeli y aluminio. Consulte pedidos mínimos.

Plastic+foam skirting with straight lines. Finishes: white, oak, sapelli and aluminium. Please consult minimum orders.

Plinthe en plastique+mousse de lignes droites. Finitions: blanc, chêne, sapelli et aluminium.

Long.: 240 cm.

19,98 €/u.

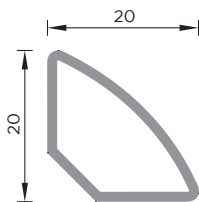

910
910R724000A

Color blanco.
White colour.
Couleur blanc.
Long.: 240 cm.

5,65 €/u.

Clickx System. Montaje / Assembly / Montage



Soporte / Support / Support.
Ref. V750000106

Accesorios / Accessories / Accessoires

COMBI SERIES

	Esquina exterior Outer corner Angle extérieur	Esquina interior Inner corner Angle intérieur	Conector Connector Embout de raccord	Terminal izdo. Left end cap Embout gauche	Terminal dcho. Right end cap Embout droit
PLÁSTICO PLASTIC PLASTIQUE					
800	V810300011	V810300012	V810300013	V810300014	V810300015
820	V810300011	V810300012	V810300013	V810300014	V810300015
830	V810300011	V810300012	V810300016	V810300017	V810300018
840	V810300011	V810300012	V810300013	V810300014	V810300015
€/u	1,02	1,02	0,88	0,88	0,88

6 SERIES

	Esquina exterior Outer corner Angle extérieur	Esquina interior Inner corner Angle intérieur	Conector Connector Embout de raccord	Terminal izdo. Left end cap Embout gauche	Terminal dcho. Right end cap Embout droit
PLÁSTICO PLASTIC PLASTIQUE					
735	V810320001	V810320002	V810320003	V810320004	V810320005
730 / 124	V810300001	V810300002	V810300003	V810300004	V810300005
736	V810330001	V810330002	V810330003	V810330004	V810330005
904	V81**00001	V81**00002	V81**00003	V81**00004	V81**00005
€/u	1,02	1,02	0,90	0,90	0,90

OFFICE SERIES

	Accesorio único: Esquina exterior / terminales izdo. y dcho. Unique accessory: Outer corner / right and left end caps Accessoire unique: Angle extérieur / embouts droit et gauche	COMBI/ OFFICE SERIES	Soporte Support Support
ALUMINIO ALUMINIUM ALUMINIUM	+ 4 Pasadores Spring pins Goupilles		
850	V810310001		V750000106
860	V810310002		
870	V810310003		
€/u	3,41		0,17

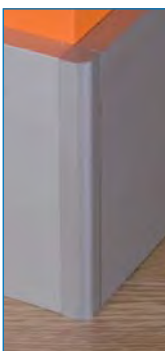



ANTIDESLIZANTE / ANTI SLIP TAPE / ANTIDÉRAPANT
AUTOADHESIVO / SELF-ADHESIVE / AUTOCOLLANT

	PRO A		B
	REF	€/un	REF
Rollo negro / Black roll / Rouleau noir - 25 mm x 5 m			V790000014 7,11
Rollo negro / Black roll / Rouleau noir - 25 mm x 18 m			V790000016 24,17
Rollo negro / Black roll / Rouleau noir - 50 mm x 5 m	V790000112	11,88	
Rollo negro / Black roll / Rouleau noir - 50 mm x 18 m	V790000117	42,67	
Rollo negro / Black roll / Rouleau noir - 100 mm x 18 m	V790000118	85,24	
Rollo fotoluminiscente / Photoluminescent / Rouleau photoluminescent - 25 mm x 5 m			V790000102 11,96
Rollo fotoluminiscente / Photoluminescent / Rouleau photoluminescent - 25 mm x 18 m			V790000111 43,07
Rollo emergencia / Emergency roll / Rouleau noir et jaune - 25 mm x 18 m			V790000124 37,55
Rollo emergencia / Emergency roll / Rouleau noir et jaune - 25 mm x 5 m			V790000126 10,44
Rollo transparente / Transparent roll / Rouleau transparent - 25 mm x 5 m			V790000130 10,44



BOTONES PODOTÁCTILES / TACTILE STUDS / CLOUS PODOTACTILES

Inox 316 25x5 mm. Estriado con tallo / Ribbed top stud / Strié avec tige	V76BDP011	2,33
Inox 316 25x5 mm. Estriado sin tallo / Ribbed top no stem / Strié sans tige	V76BDP013	1,34
Inox 316 25x5 mm. Liso sin tallo / Flat surface no stem / Lisse sans tige	V76BDP012	1,29



BANDEJA PARA CALZADO / BOOT TRAY / PATEAU POUR CHAUSSURES

BASMAT

Bandeja de plástico negro 755x380x3 mm / Plastic tray black 755x380x3 mm / Plateau en plastique couleur noir 755x380x3 mm	K2021	-
---	-------	---



DESINFECCIÓN

Solución desinfectante pulverizador 1 litro	K2022	-
Solución desinfectante envase de 5 litros	K2024	-



**CINTA DE DOBLE CARA
DOUBLE SIDED TAPE
ADHÉSIF DOUBLE FACE**

Blister - Blister - Libre Service

	REF	€/un
Rollo polipropileno / Polypropylene roll / Rouleau polypropylène - 10 m x 50 mm	V780000011	3,18
Rollo polipropileno / Polypropylene roll / Rouleau polypropylène - 25 m x 50 mm	V780000012	6,02
Rollo gasa / Cotton tissue roll / Rouleau toile de coton - 10 m x 50 mm	V780000013	4,61
Rollo gasa / Cotton tissue roll / Rouleau toile de coton - 25 m x 50 mm	V780000014	9,76



Ref. V760000078

Ref. V760000074

**HERRAMIENTAS PARA CORTAR PERFILES
TOOLS FOR CUTTING PROFILES
OUTILS POUR LA COUPE DE PROFILS**

Blister - Blister - Blister

	REF	€/un
Tijeras corta metal / Scissors for metal / Ciseaux pour métaux	V760000074	13,56
Minisierra para metal / Mini hacksaw / Mini scie à métaux	V760000078	5,91
5 hojas para minisierra / 5 blades for mini hacksaw / 5 lames pour mini scie	V760000079	5,31



Ref. V760000060

Ref. V760000077

**CUTTER Y CUCHILLAS
CUTTER AND BLADES
CUTTER ET LAMES**

	REF	€/un
Blister 10 cuchillas / 10 blades blister / Blister 10 lames	V760000071	2,54
Cutter auto retráctil blister + 2 cuchillas dobles / Self retracting cutter blister + 2 double blades / Cutter auto rétractable blister + 2 lames dou.	V760000077	5,81
Cutter blister / Cutter blister / Cutter blister	V760000060	9,96



BROCAS / DRILL BITS / MÈCHES

	REF	€/un
Broca + broca avellanadora / Drill bit + Countersink drill bit / Fraise d'encastrement de têtes de vis + mèche	V750000104	16,70

EXP-001

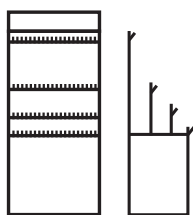

80 referencias
60 ref. de hasta 93 cm
20 ref. de hasta 180 cm

80 references
60 ref. up to 93 cm
20 ref. up to 180 cm

80 références
60 réf. jusqu'à 93 cm
20 réf. jusqu'à 180 cm
Dim. 98x70x224 cm



EXP-004

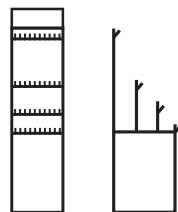

40 referencias
30 ref. de hasta 93 cm
10 ref. de hasta 180 cm

40 references
30 ref. up to 93 cm
10 ref. up to 180 cm

40 références
30 réf. jusqu'à 93 cm
10 réf. jusqu'à 180 cm
Dim. 52x70x224 cm



EXP-003

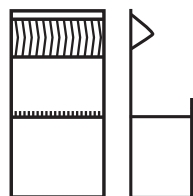

20 ref. + 12 ref. largas
20 ref. de hasta 93 cm
12 ref. de hasta 270 cm

20 ref. + 12 long ref.
20 ref. up to 93 cm
12 ref. up to 270 cm

20 réf. + 12 réf. longues
20 réf. jusqu'à 93 cm
12 réf. jusqu'à 270 cm
Dim. 98x70x198 cm



EXP-006

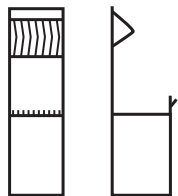

10 ref. + 6 ref. largas
10 ref. de hasta 93 cm
6 ref. de hasta 270 cm

10 ref. + 6 long ref.
10 ref. up to 93 cm
6 ref. up to 270 cm

10 réf. + 6 réf. longues
10 réf. jusqu'à 93 cm
6 réf. jusqu'à 270 cm
Dim. 52x70x198 cm



EXP-007

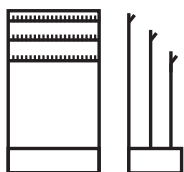

66 referencias
22 ref. de hasta 90 cm
44 ref. de hasta 93 cm

66 references
22 ref. up to 90 cm
44 ref. up to 93 cm

66 références
22 réf. jusqu'à 90 cm
44 réf. jusqu'à 93 cm
Dim. 100x50x143 cm



EXP-014

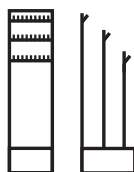

30 referencias
20 ref. de hasta 90 cm
10 ref. de hasta 93 cm

30 references
20 ref. up to 90 cm
10 ref. up to 93 cm

30 références
20 réf. jusqu'à 90 cm
10 réf. jusqu'à 93 cm
Dim. 50x50x143 cm



EXP-100

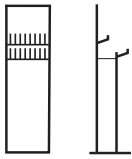

16 referencias
16 ref. de hasta 93 cm

16 références
16 ref. up to 93 cm

16 références
16 réf. jusqu'à 93 cm

Dim. 40x41x153 cm



EXP-009

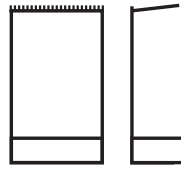

8 espacios para perfiles largos de hasta 270 cm
8 spaces for up to 270 cm long profiles
8 espaces pour profils longs jusqu'à 270 cm de longueur
Dim. 70x40x142 cm



EXP-022

NEW!
NUEVO
NOUVEAU

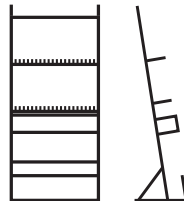

20 espacios para perfiles largos de hasta 270 cm
20 spaces for up to 270 cm long profiles
20 espaces pour profils longs jusqu'à 270 cm de longueur
Dim. 100x50x200 cm



BASIC LINE

Acero / Steel / Acier

			
01 Inox St. steel Acier inoxydable	23 Inox 1 mm St. steel 1 mm Acier inoxydable 1 mm	26 Inox 1,2 mm St. steel 1,2 mm Acier inox. 1,2 mm	06 Acero latonado Brass plated steel Acier laitonné

Otros acabados / Other finishes / Autres finitions

							
11 Haya 11 Beech 11 Hêtre 11	12 Sapeli 12 Sapelli 12	13 Roble 13 Oak 13 Chêne 13	14 Cerezo 14 Cherry 14 Cerisier 14	17 Haya vaporizada 17 Steam beech 17 Hêtre 17	19 Cerezo claro 19 Light cherry 19 Cerisier clair 19		
							
28 Arce 28 Maple 28 Érable 28	30 Roble oscuro 30 Dark oak 30 Chêne foncé 30	31 Jatoba 31 Red mahogany 31 Jatoba 31	33 Roble rústico 33 Old oak 33 Chêne antique 33	35 Wengé 35 Wenge 35	37 Nogal 37 Walnut 37 Noyer 37	P1 Roble gris claro P1 Light grey oak P1 Chêne gris clair P1	P2 Roble blanco P2 White oak P2 Chêne blanc P2
							
P3 Roble blanco loft P3 Loft white oak P3 Chêne blanc loft P3							



Ref. V800000045

COLORES DIGITALES

Gracias a la tecnología digital, Baglinox puede incorporar nuevos acabados a partir de una muestra de pavimento. Disponible para los perfiles fabricados con aluminio. Consulte condiciones.

DIGITAL COLOURS

Thanks to the digital technology, Baglinox can add more finishes from a flooring sample. Available for aluminium profiles. Please consult conditions.

COULEURS NUMÉRIQUES

Grâce à la technologie numérique, Baglinox peut incorporer des nouvelles finitions à partir d'un échantillon. Disponible pour les profils en aluminium. Veuillez consulter les conditions applicables.

